

HUSTLER-BILDKRAFT

U.S.A.

TYPE	Constructional Engineering	
HOLE DIAMETER	3.8mm - 4.1mm	HOLE SPACING 12.7mm (0.5 ins.)
SETS IN SYSTEM	Total of 3: I.2.3.	
DIFFERENT PARTS	30	
COLOUR	Black, red and Nickel Plated	
FIXING METHOD	Nut and bolt - 6-32	
MOTORS	None	
PERIOD	1930's	
MANUFACTURER	Hustler Toy Co., Illinois. U.S.A.	
COMMENTS	A very limited system. Pulleys are wooden with metal inserts.	
OTHER SYSTEMS NEWSLETTER	28/820, 49/1499	

MATERIAL SUPPLIED BY Clyde.T.Suttle.

**Hustler  
Bildkraft**  
*Builds  
Life Like  
Models*

**Hustler  
Bildkraft**  
*Builds  
Life Like  
Models*

## Hustler Toys and Games

The slogan "Hustler Toys for girls and boys" and the Hustler trade mark stand for quality and originality in the production of toys.

Hustler toys are carried in stock by all leading stores. You can buy them at the store from which your Hustler Bildkraft was purchased. They are strongly made and very life-like in action. Each toy is packed in an attractive carton.

The Hustler line of games includes the Great American Baseball Game, Intercollegiate Football Game and many others.

## Hustler Toy Corporation

Sterling, Illinois

**Hustler  
Bildkraft**  
*Price  
List*

**Hustler  
Bildkraft**  
*Price  
List*

Hustler  
Bildkraft  
Builds  
Life Like  
Models

Hustler  
Bildkraft  
Builds  
Models  
in Colors



NO. 4 1"-PULLEY

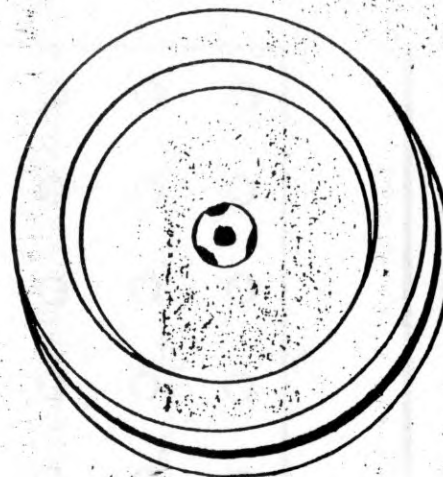

NO. 2 2 1/2"-PULLEY



NO. 3  
CYLINDER



NO. 30  
DOUBLE HOLE  
COLLAR

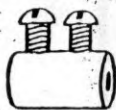

NO. 18  
SPLICE COLLAR

NO. 19 BOLT



NO. 20 NUT

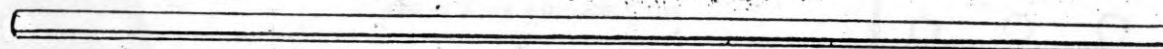

NO. 27 6"-AXLE

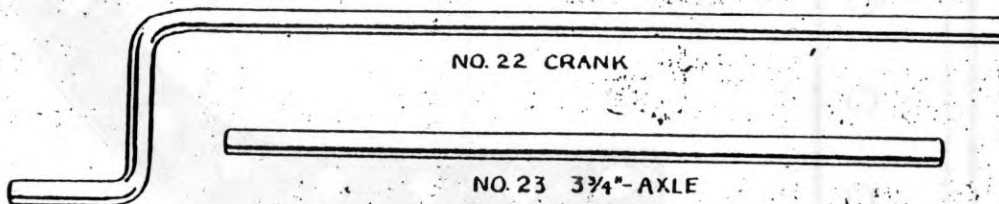

NO. 22 CRANK

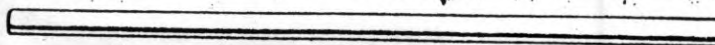

NO. 23 3 3/4"-AXLE

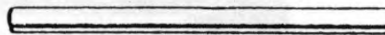

NO. 24 2"-AXLE



NO. 17 COLLAR

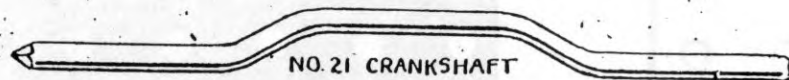

NO. 21 CRANKSHAFT



NO. 1  
CRANE HOOK

Hustler  
Bildkraft  
Parts  
List

Hustler  
Bildkraft  
Parts  
List

**Hustler  
Bildkraft**  
*Builds  
Life Like  
Models*

**Hustler  
Bildkraft**  
*Builds  
Models  
in Colors*

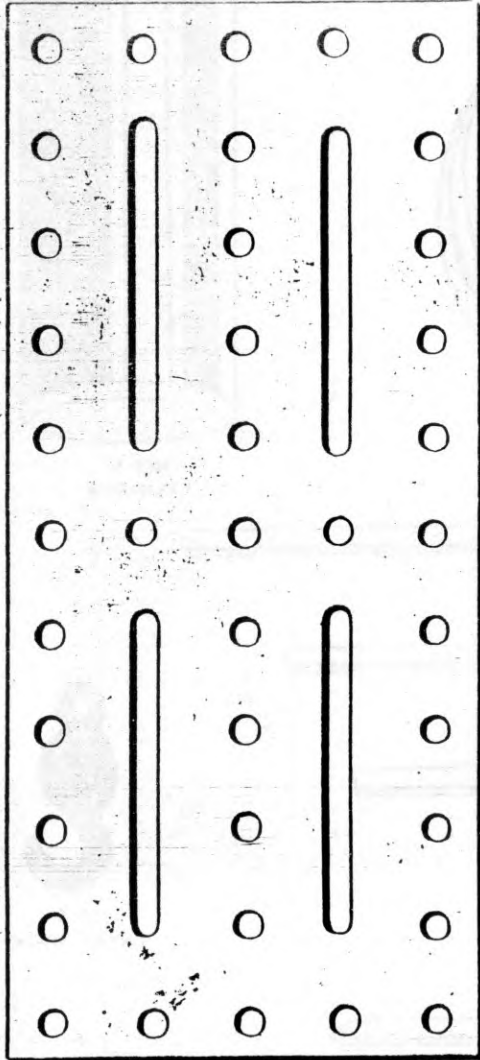

NO. 6 OBLONG BASE PLATE

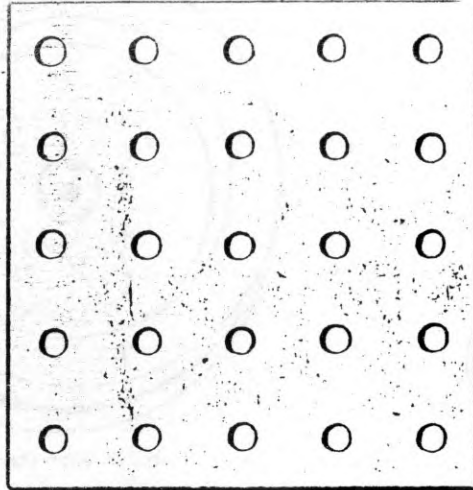

NO. 7 SQUARE BASE PLATE



NO. 16  
ANGLE  
BRACKET



NO. 12  
SPLICE PLATE

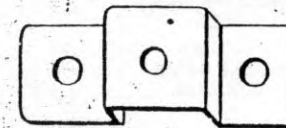

NO. 15 DOUBLE BENT STRIP

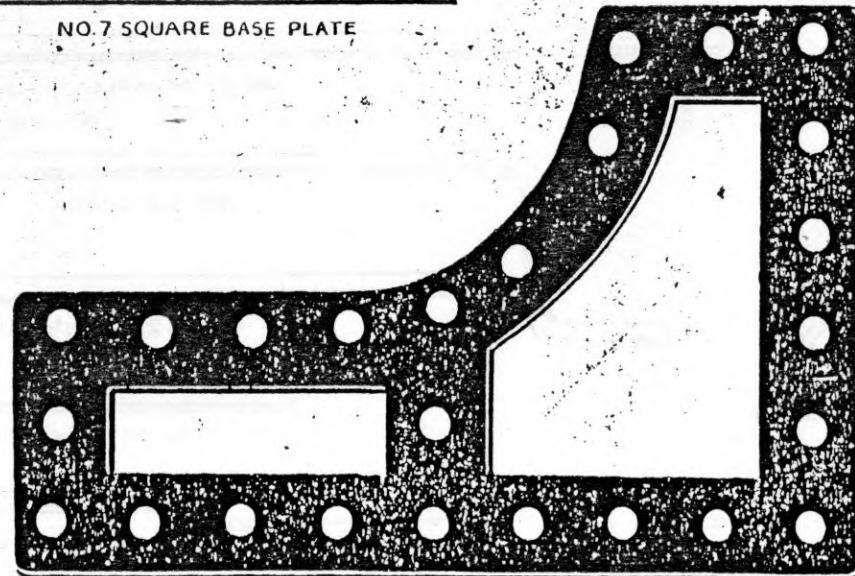

NO. 5. ADJUSTABLE FRAME PLATE

**Hustler  
Bildkraft**  
*Parts  
List*

**Hustler  
Bildkraft**  
*Parts  
List*



Hustler  
Bildkraft  
Builds  
Life Like  
Models

Hustler  
Bildkraft  
Builds  
Models  
in Colors



NO 8 11-HOLE PERFORATED STRIP



NO 9 7-HOLE PERFORATED STRIP

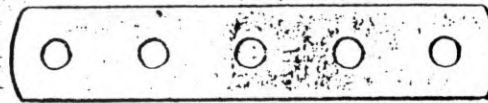

NO 10 5-HOLE PERFORATED STRIP

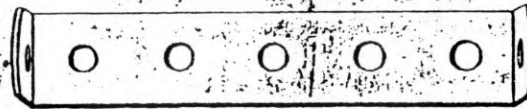

NO 11 DOUBLE ANGLE STRIP

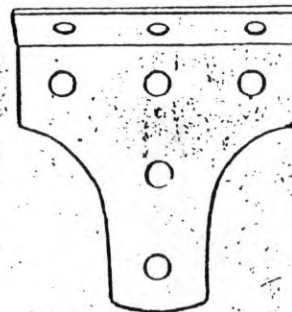

NO 14 TRUNNION



NO 13  
CURVED STRIP

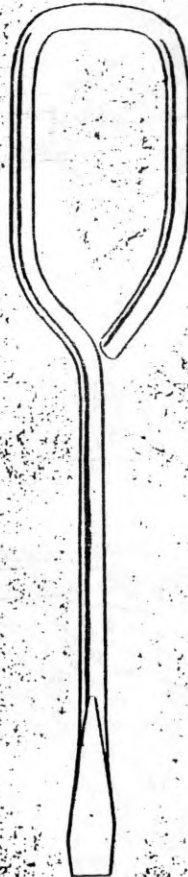

NO 25  
4 1/2\"/>

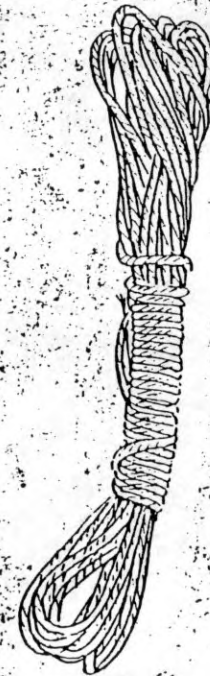

NO 28  
CORD  
(2 YARDS)



NO 29  
PROPELLER

Hustler  
Bildkraft  
Parts  
List

Hustler  
Bildkraft  
Parts  
List

**Hustler  
Bildkraft**  
*Builds  
Life Like  
Models*

**Hustler  
Bildkraft**  
*Builds  
Models  
in Colors*

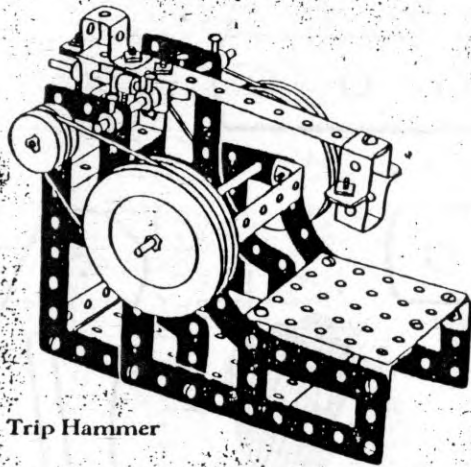

**Trip Hammer**

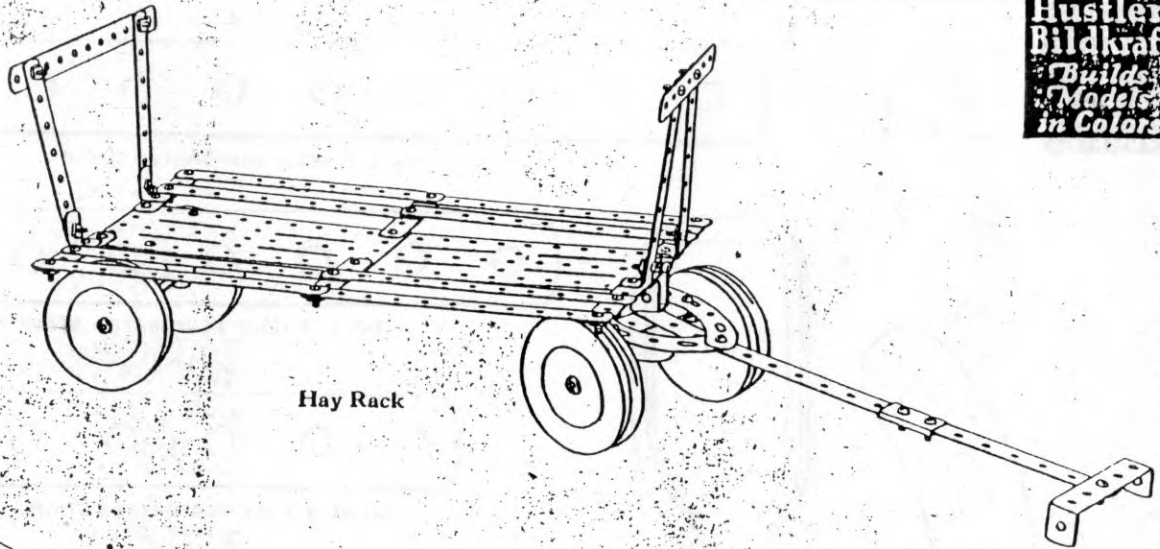

**Hay Rack**

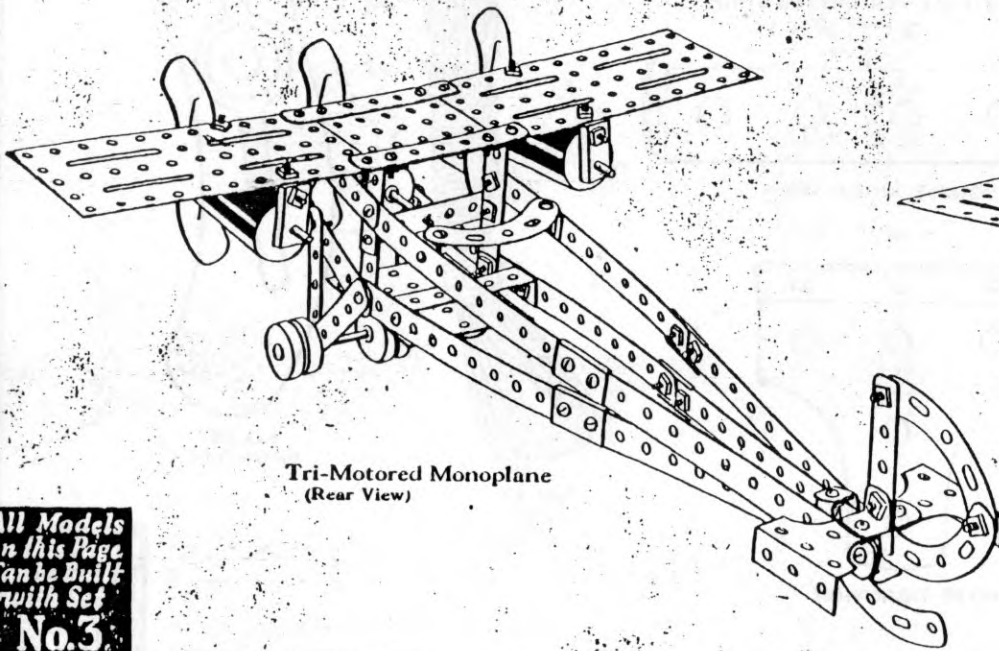

**Tri-Motored Monoplane  
(Rear View)**

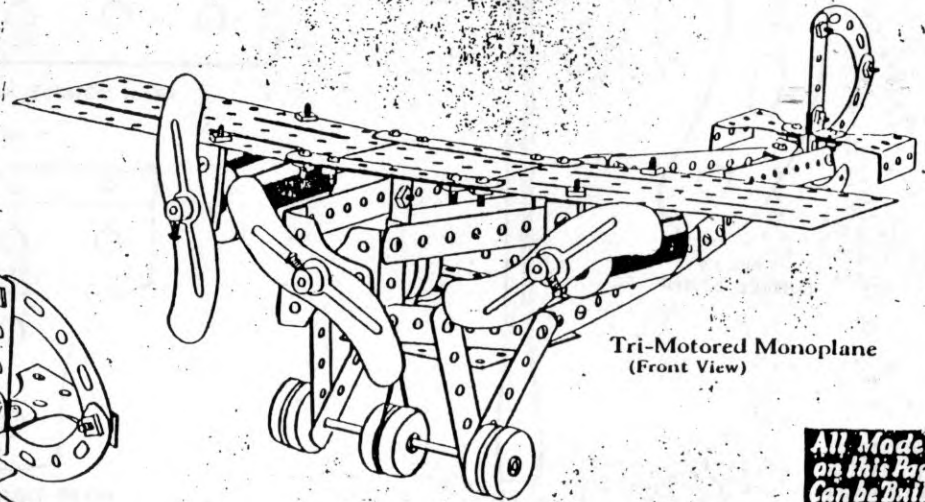

**Tri-Motored Monoplane  
(Front View)**

**All Models  
on this Page  
Can be Built  
with Set  
No.3**

**All Models  
on this Page  
Can be Built  
with Set  
No.3**