

4

scienza
gioco &

TECNOLOGICA

Laboratorio di **MECCANICA** MACCHINARI IDRAULICI

Costruzioni da **15** a **20**

- 15-L'elevatore verticale
- 16-La gru con contrappeso
- 17-La gabbia
- 18-La pinza
- 19-La diga
- 20-Lo scrigno

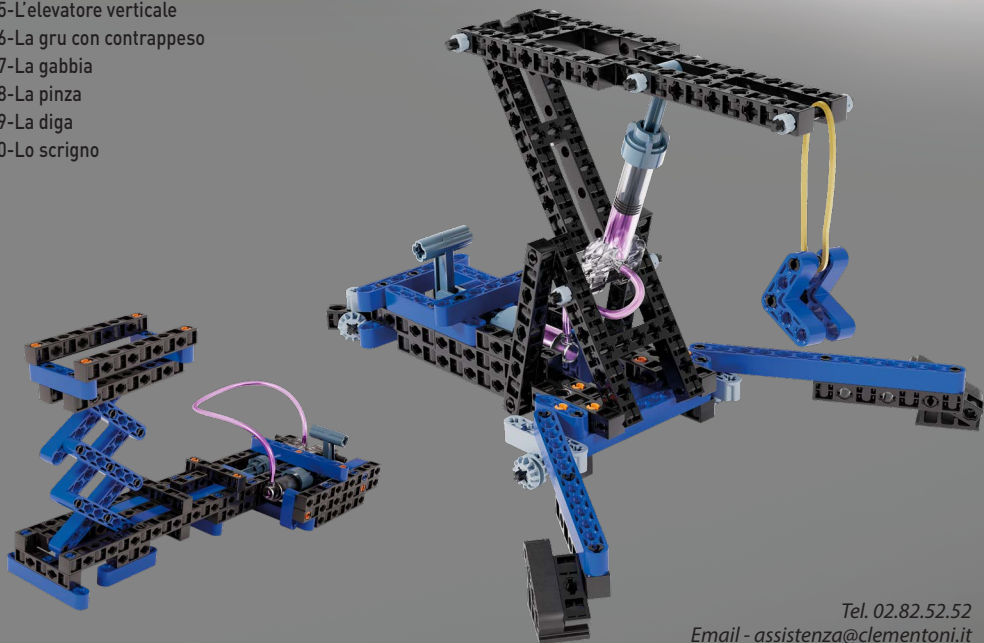

Manuale da leggere e
conservare per future
referenze.

Tel. 02.82.52.52
Email - assistenza@clementoni.it
Clementoni S.p.A.

Zona Industriale Fontenoce s.n.c.
62019 Recanati (MC) - Italy
Tel.: +39 071 75811
www.clementoni.com



Assistenza clienti

Tel. 02.82.52.52

Email - assistenza@clementoni.it



Clementoni

3

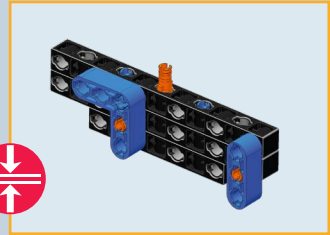
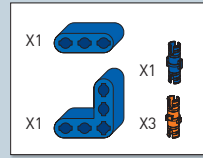
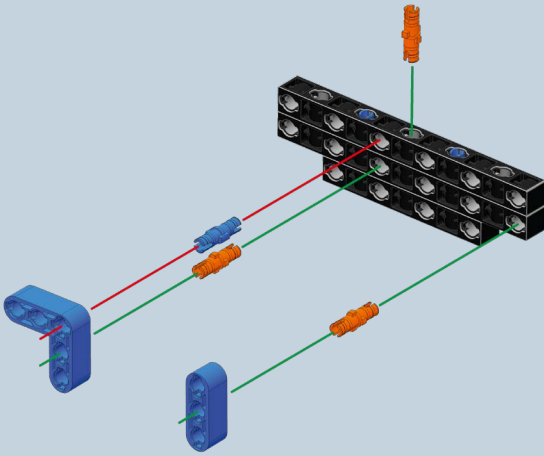

4

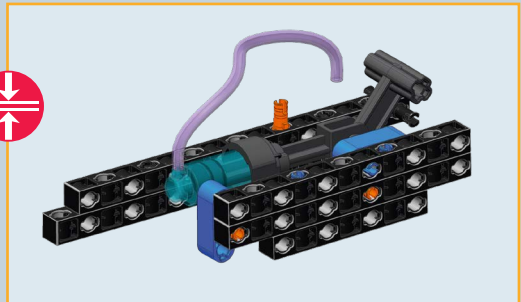
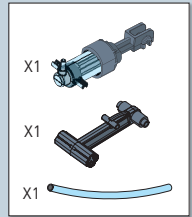
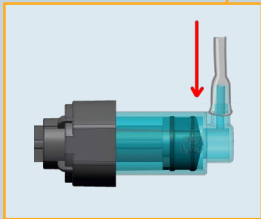
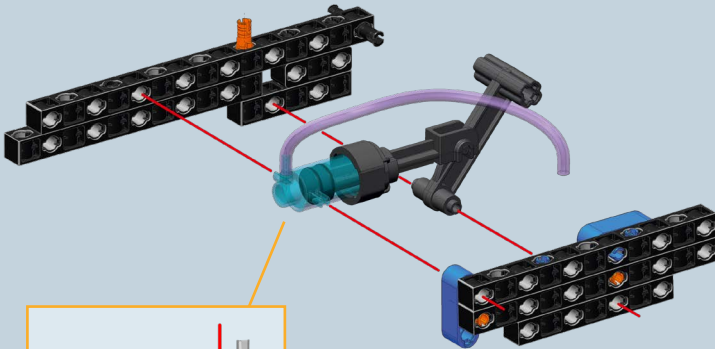

5

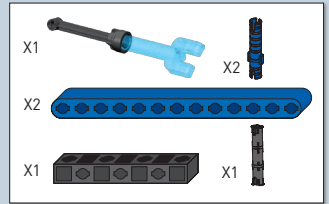
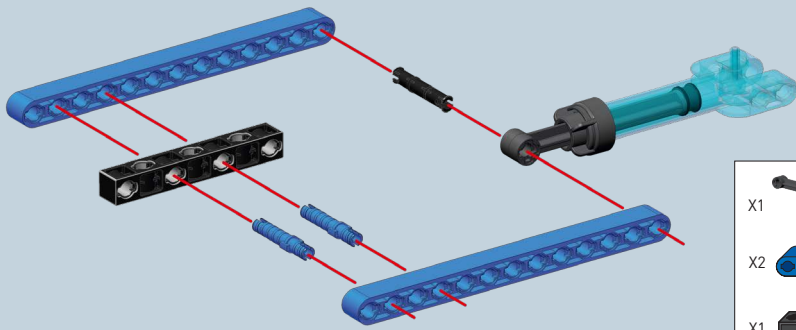

6

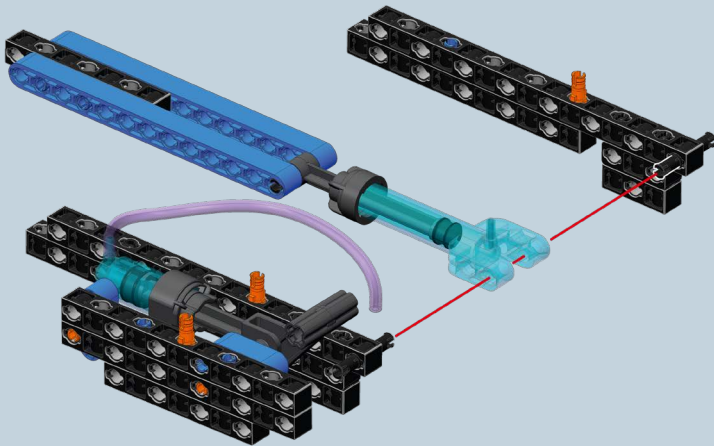

7

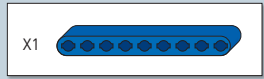
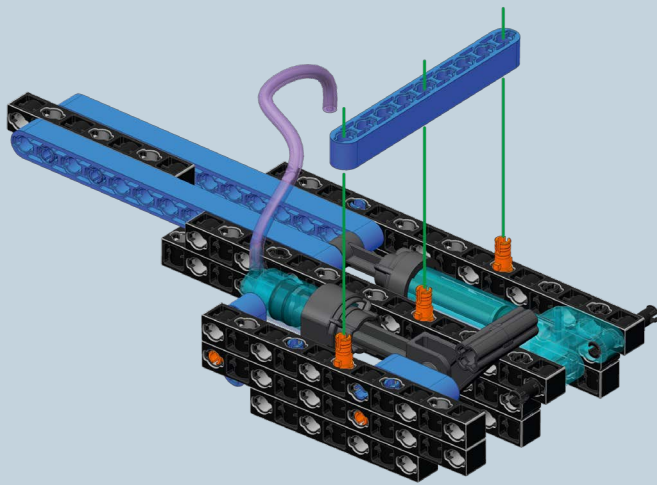

8

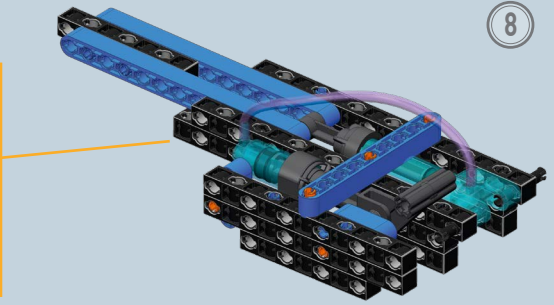
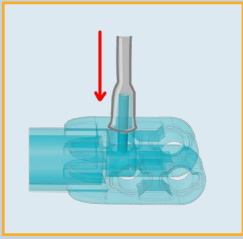

9

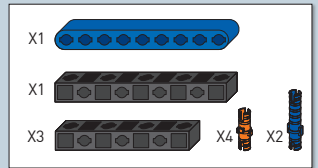
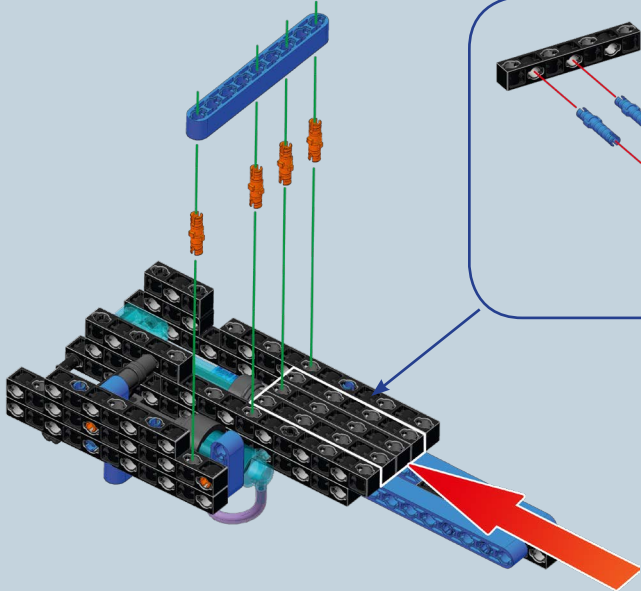
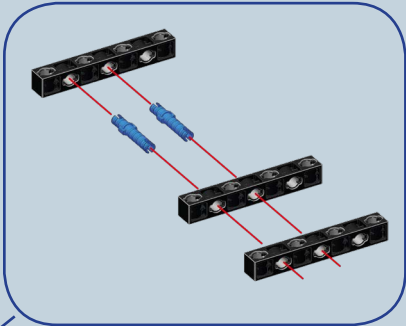

10

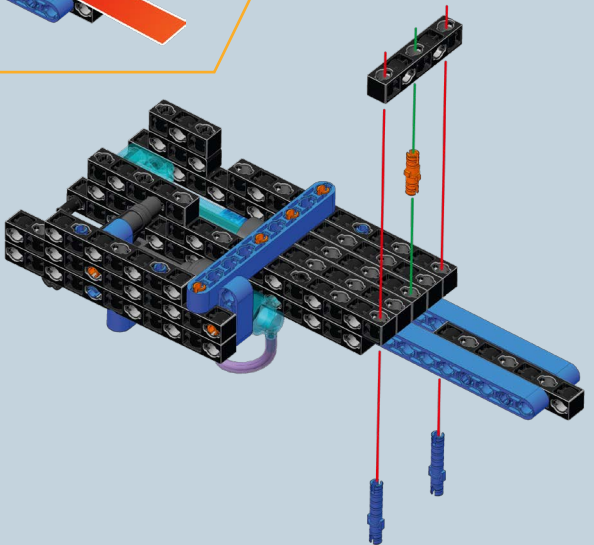

11

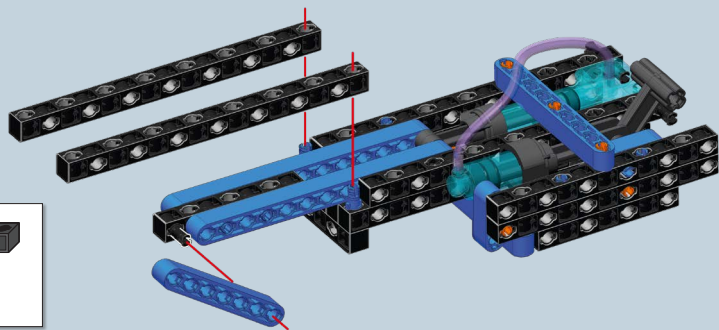

| | |
|----|--|
| X2 | |
| X1 | |
| X1 | |

12

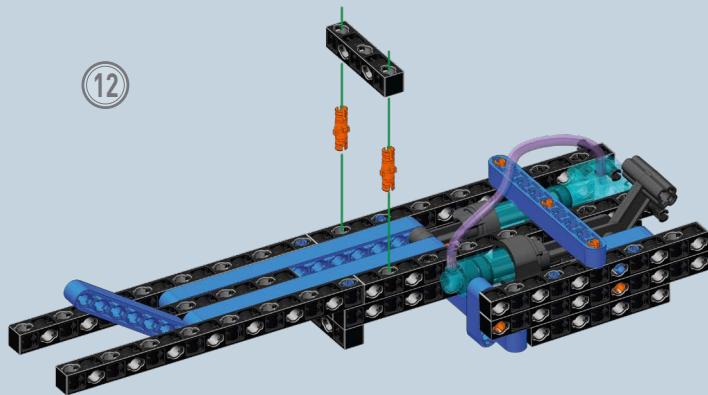

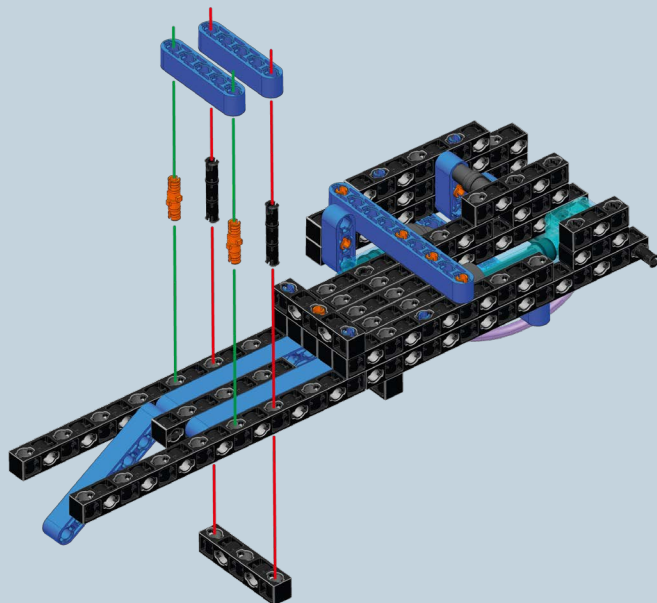

| | | | |
|----|--|----|--|
| X1 | | X2 | |
|----|--|----|--|

13



| | | | |
|----|--|----|--|
| X1 | | X2 | |
| X2 | | X2 | |



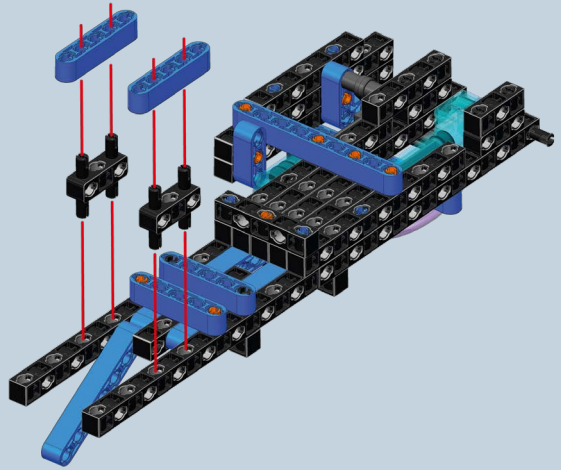

14

- X2 
- X2 

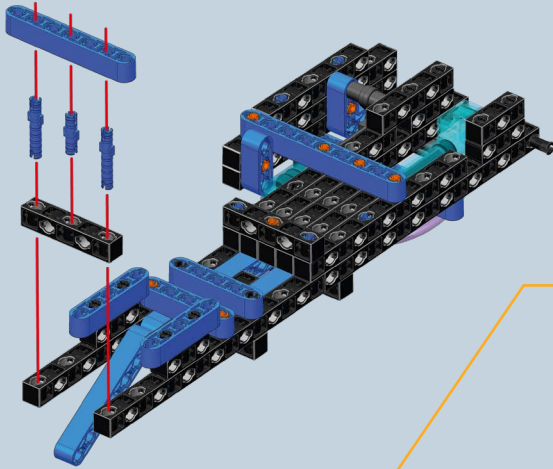

15





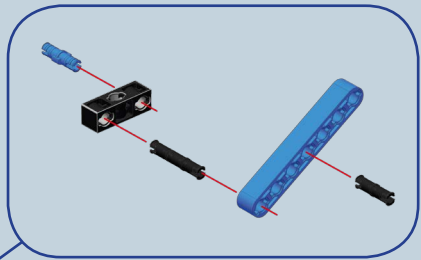

- X1 
- X1 
- X1 
- X2 

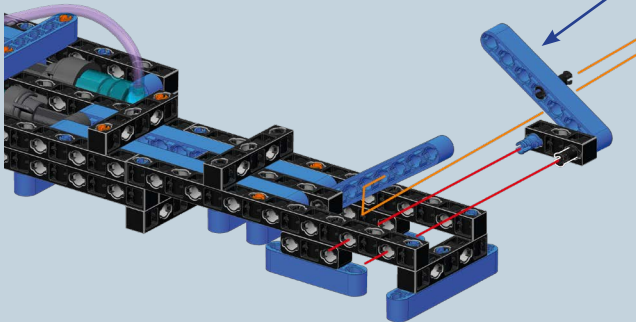

16



- X1 
- X1 
- X1 
- X1 
- X1 

17

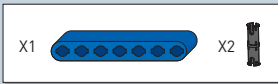
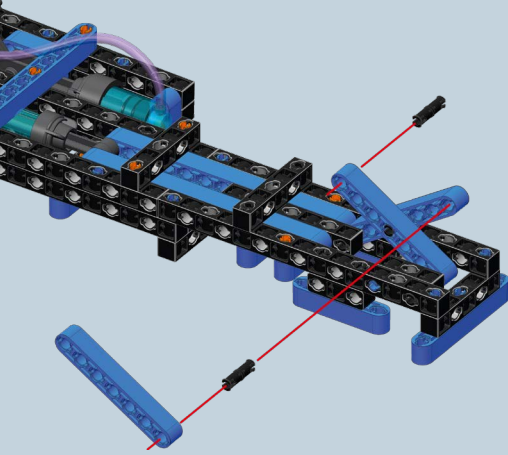

18

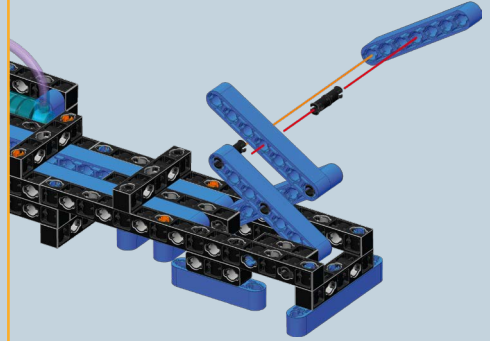

19

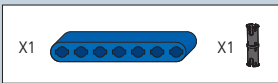
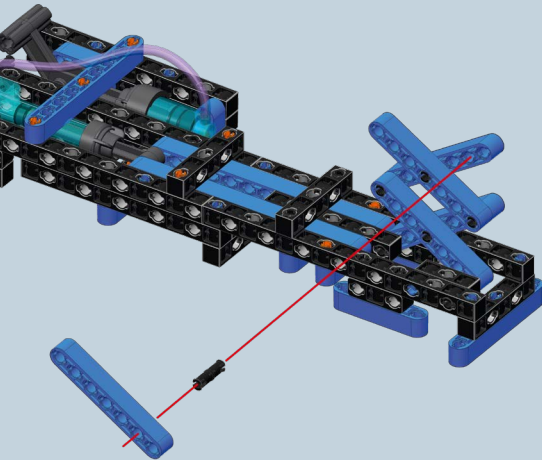

20

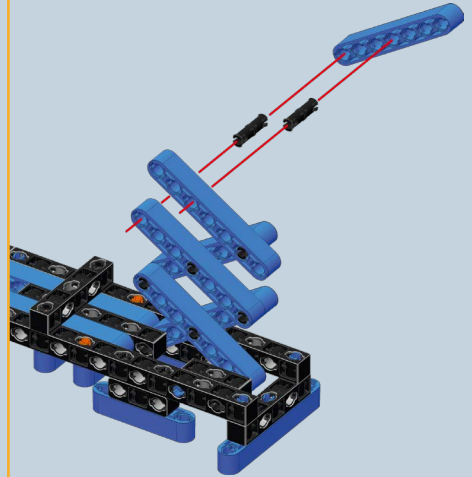

21

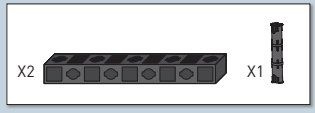
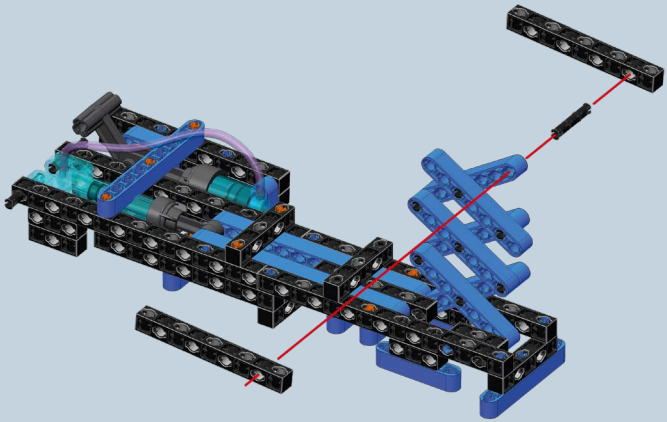

22

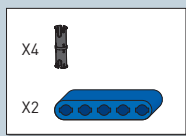
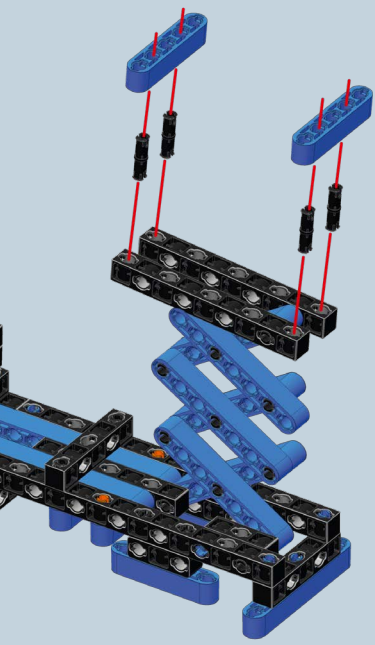

23

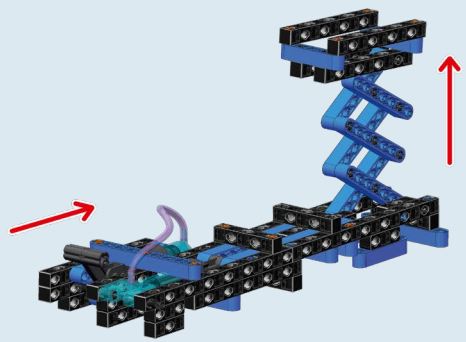
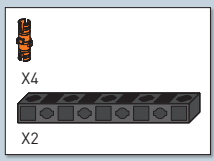
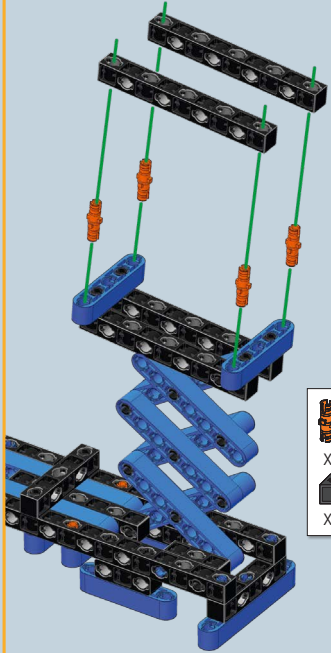

Modello finale

16 La gru con contrappeso

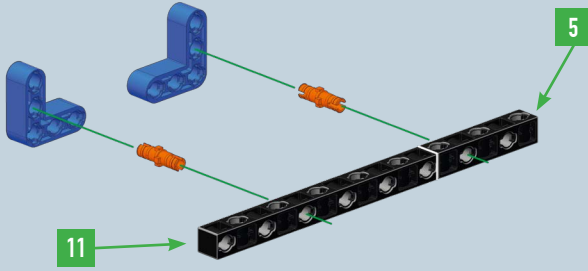

1

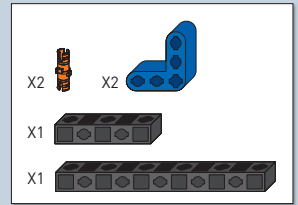

2

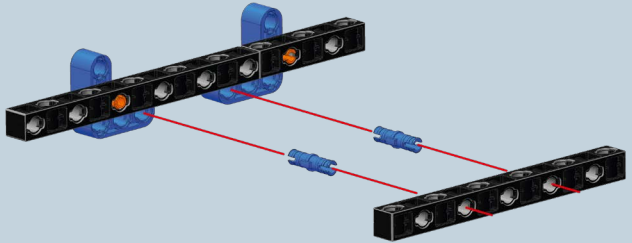

3

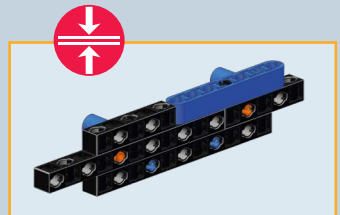
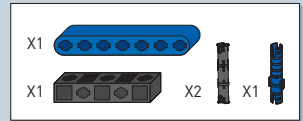
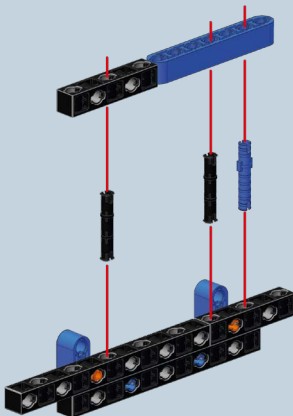

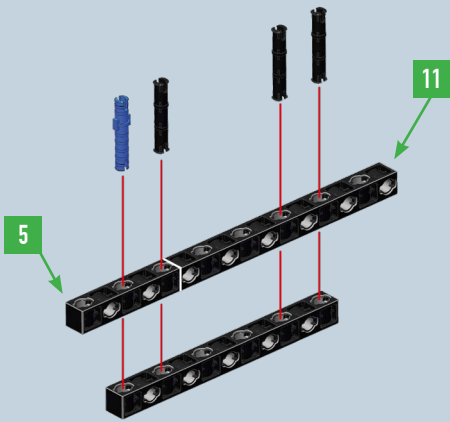

4

- X1
- X3
- X1
- X2

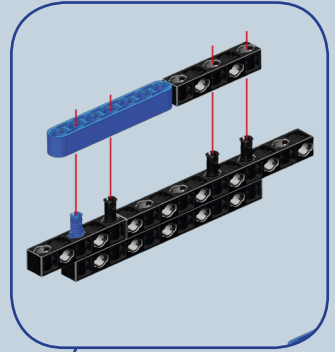

5

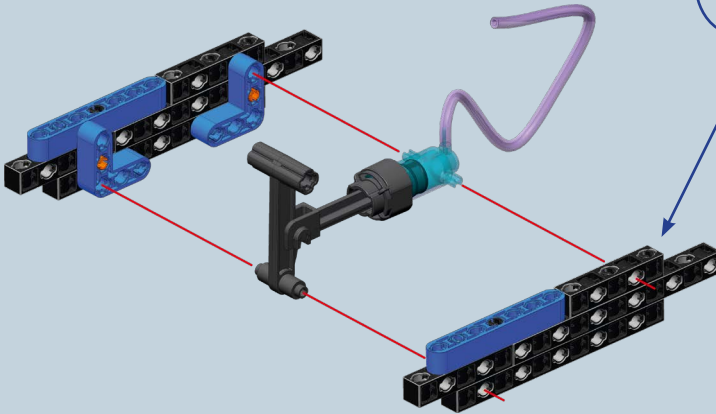

- X1
- X1
- X1
- X1
- X1

6

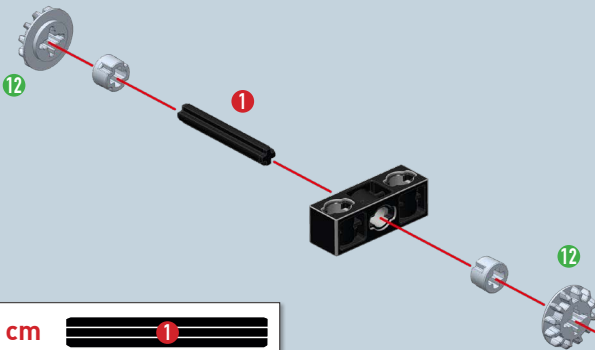

2,7 cm

- X1
- X1
- X2
- X2

7

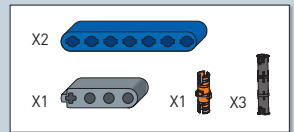
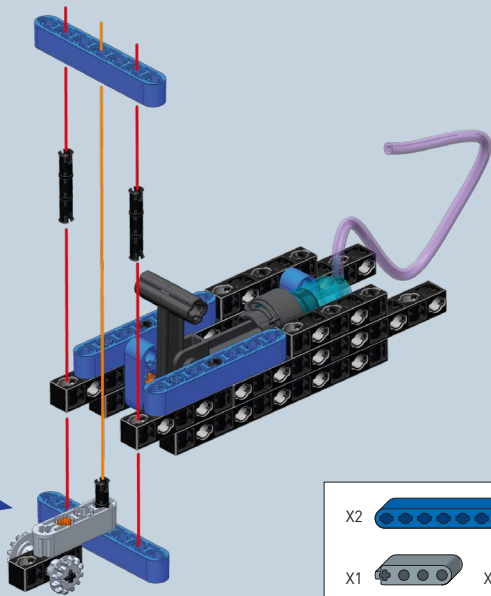
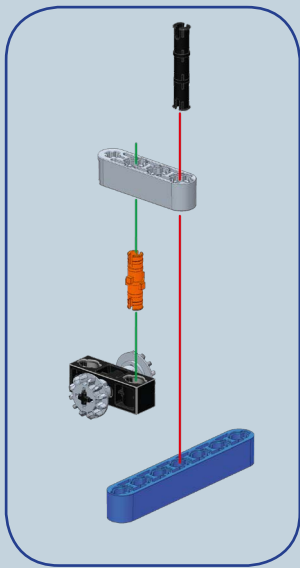

8

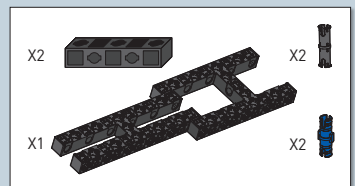
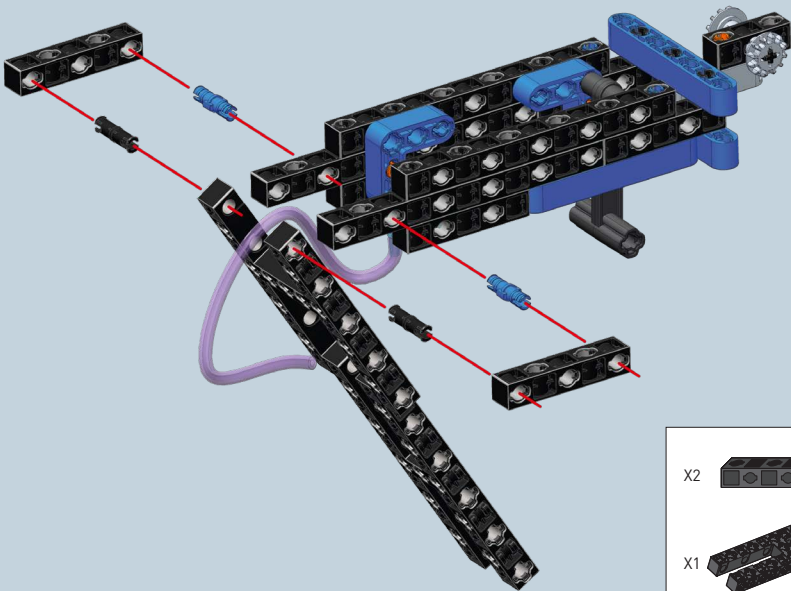

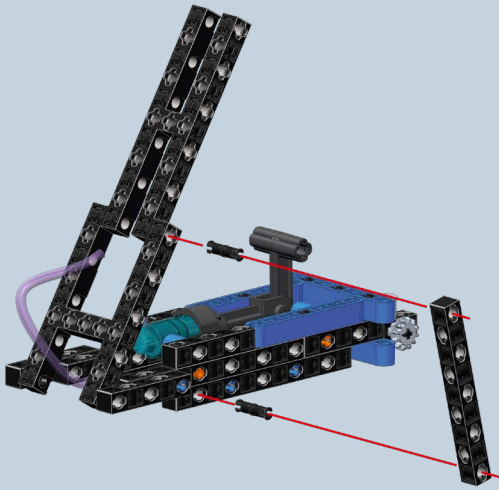

9

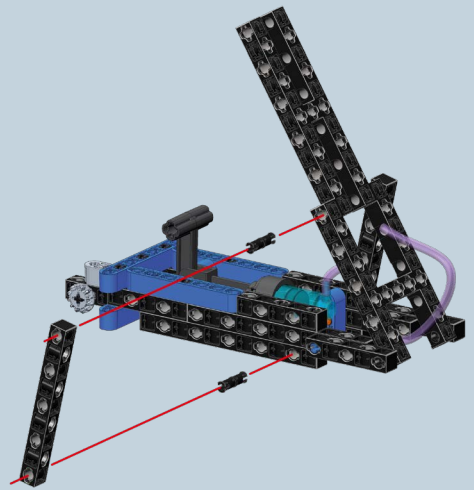
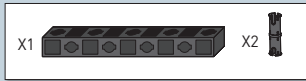

10

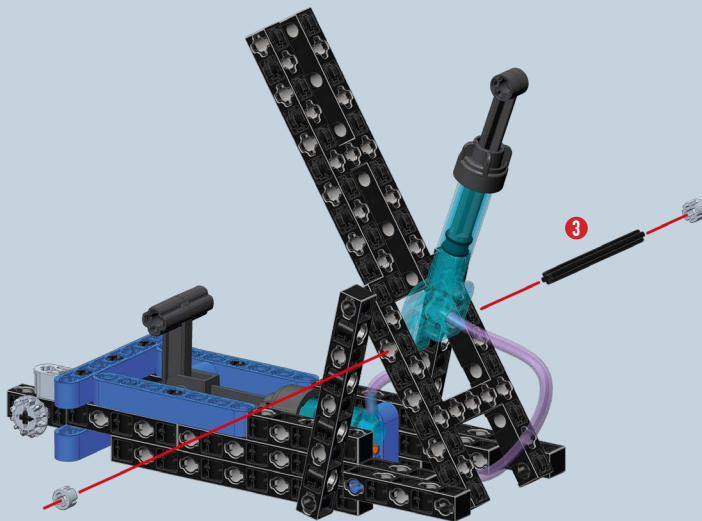

11

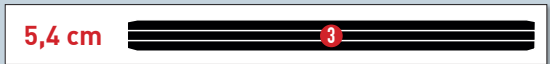

12

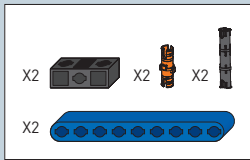
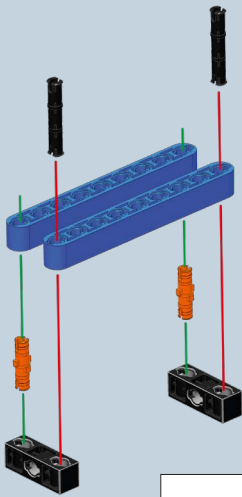

13

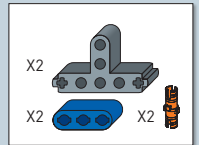
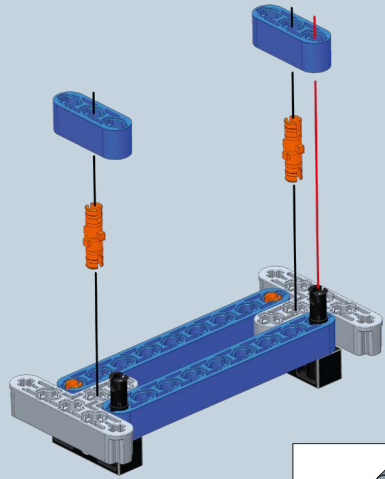

14

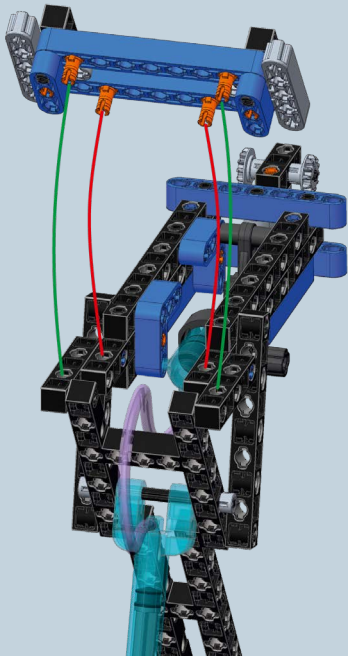

5,4 cm



3,6 cm



15

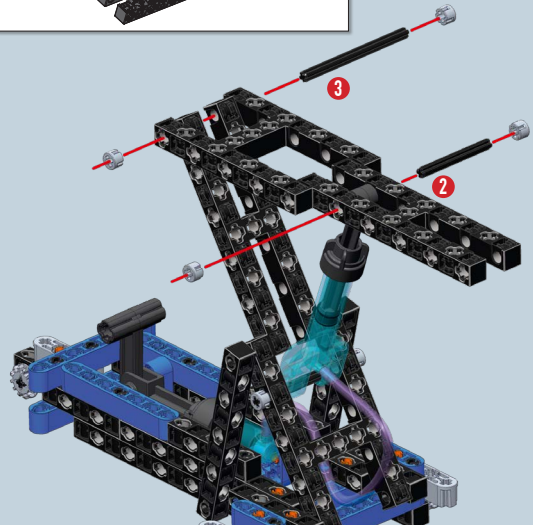
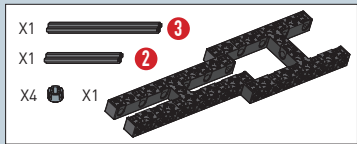

16

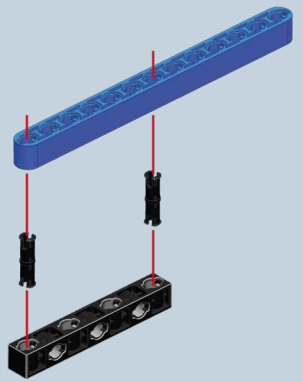
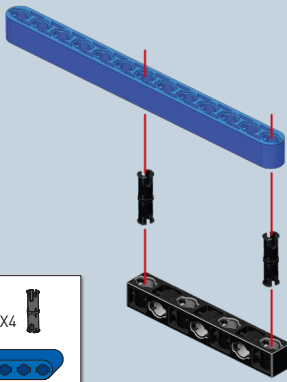
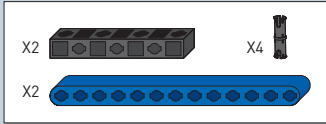

17

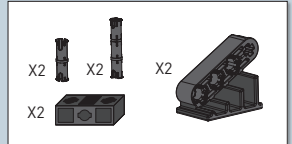
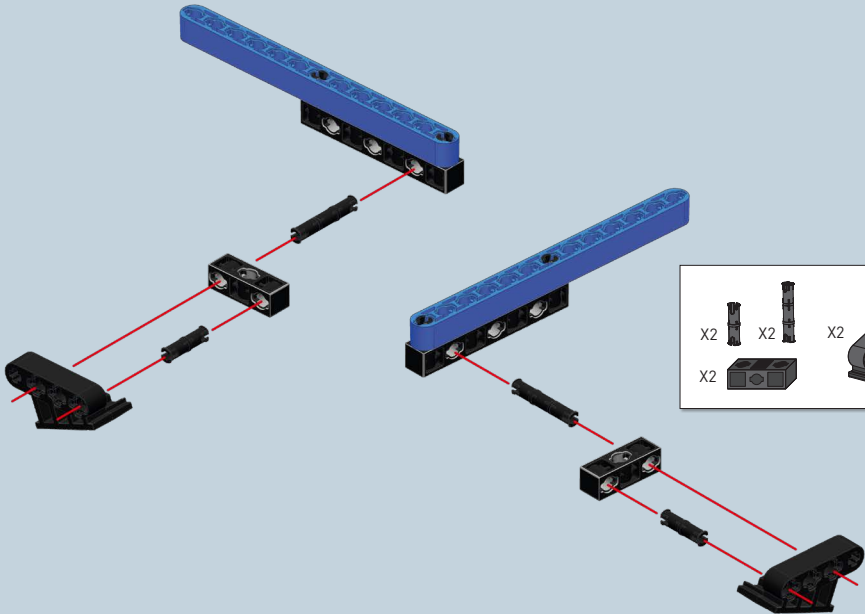

18

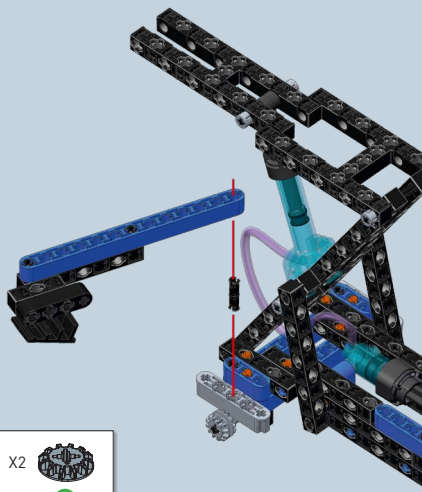

19

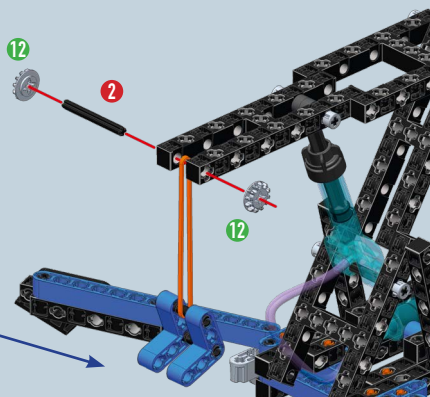
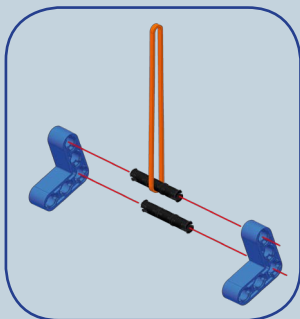
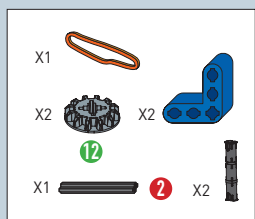
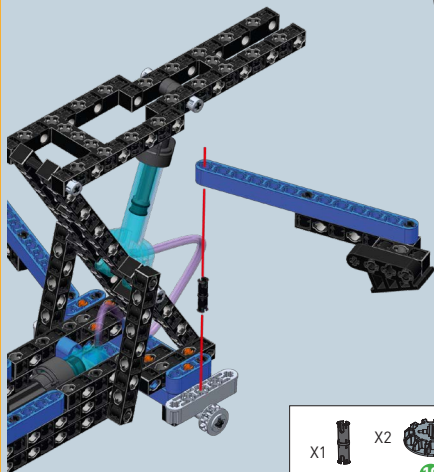

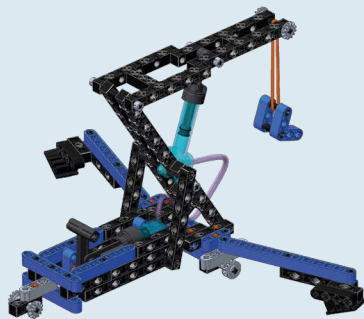
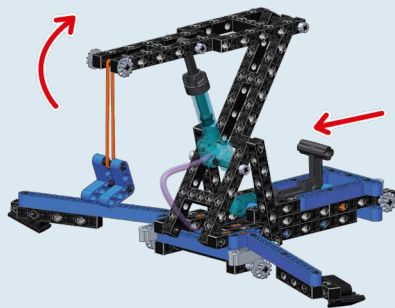
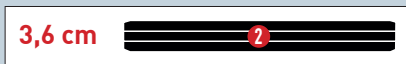

20

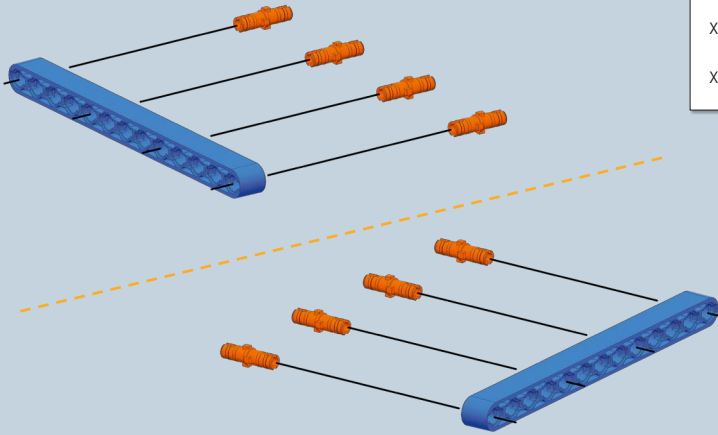
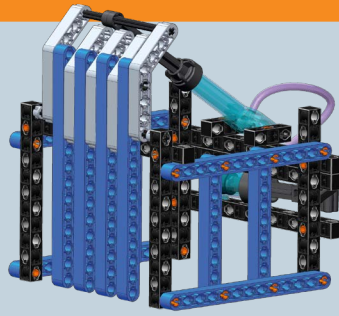

Modello finale

17 La gabbia





X8 

X2 

1

X2 

X4  X4 

2

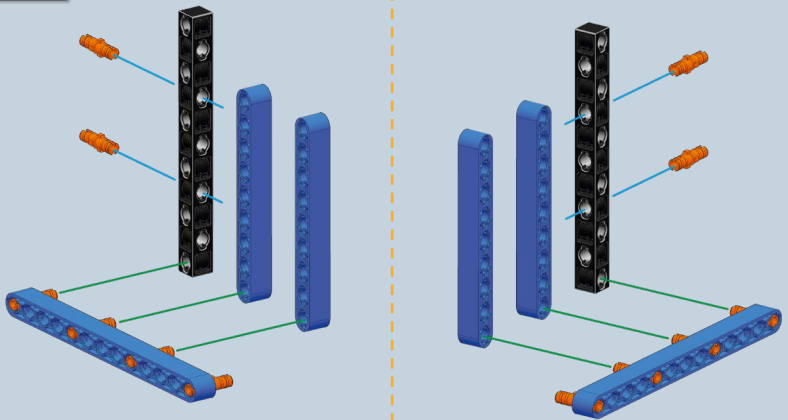

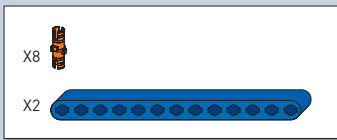

3

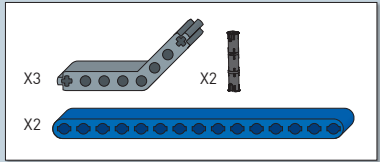
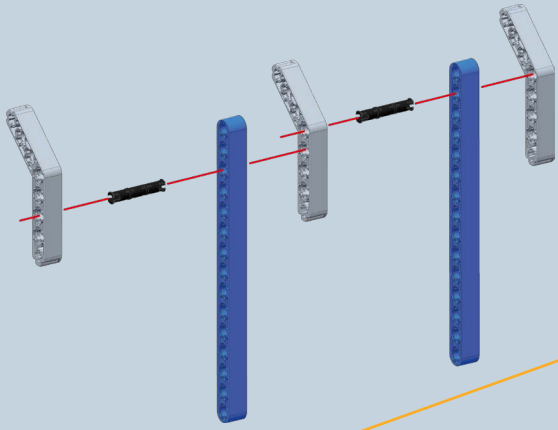
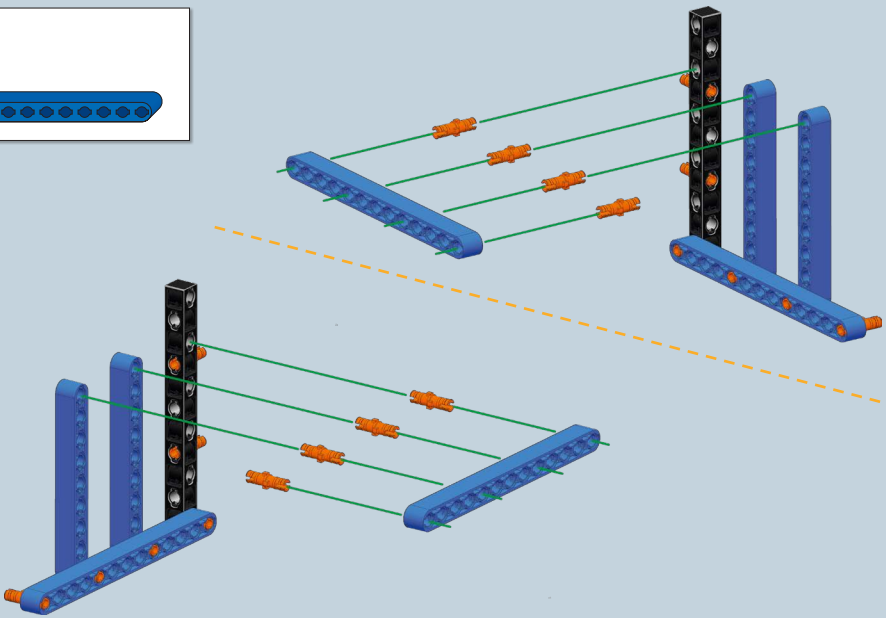

4

5

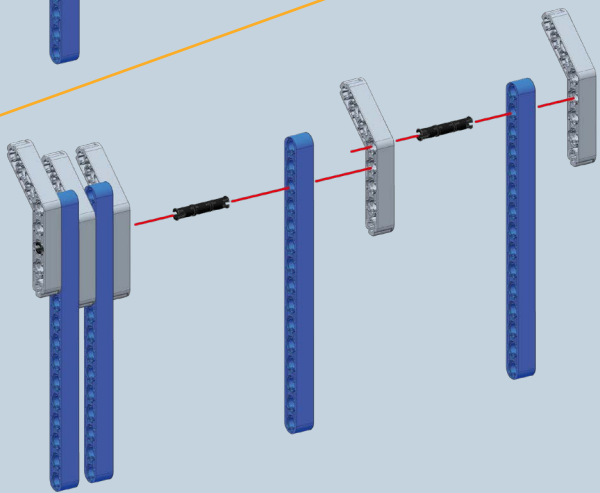
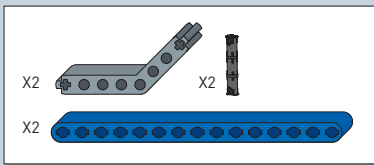

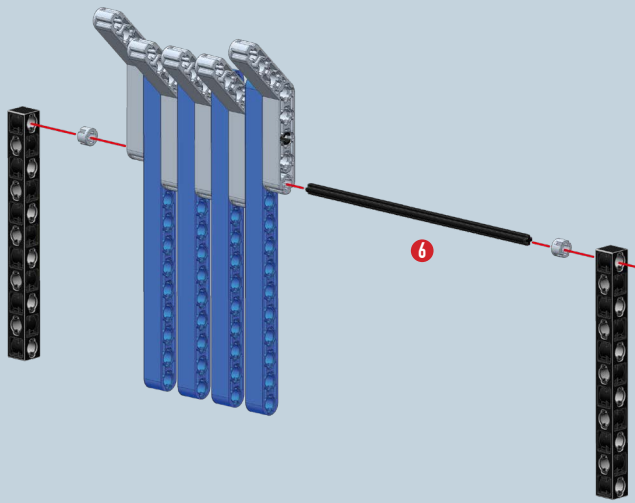

| | | | |
|----|--|----|----------|
| X2 | | X2 | |
| X1 | | | 6 |

6

11,7 cm

| | | | |
|----|--|----|--|
| X1 | | X2 | |
|----|--|----|--|

7

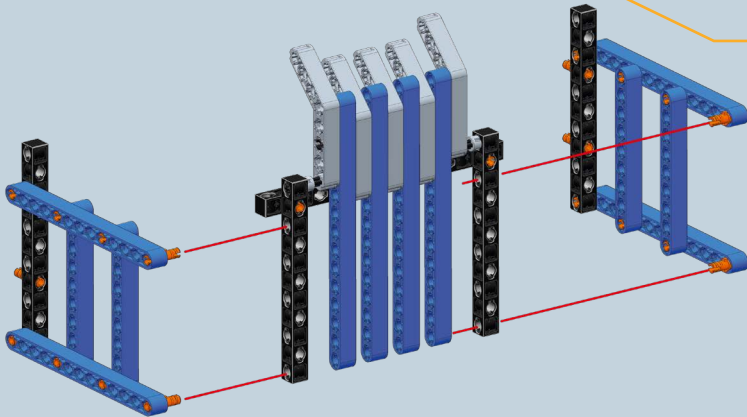
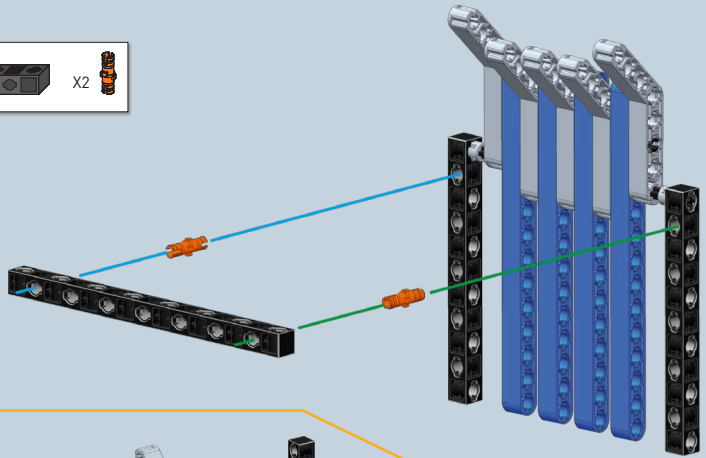

8

9

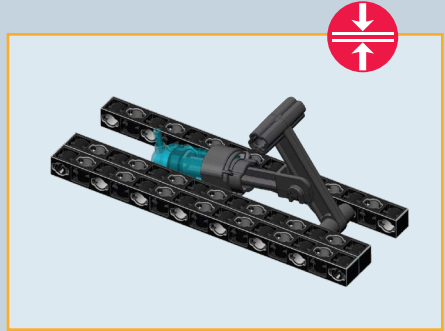
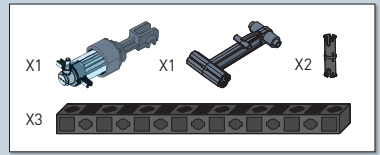
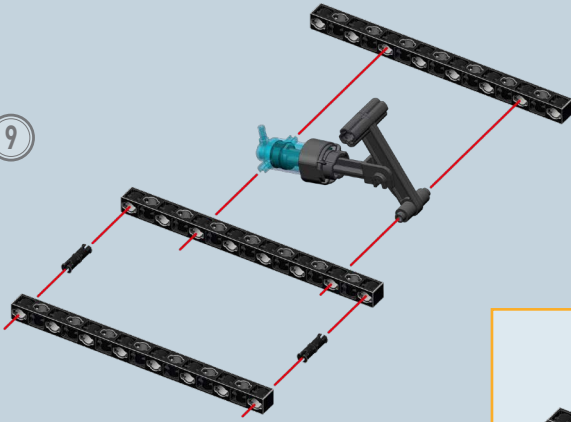

10

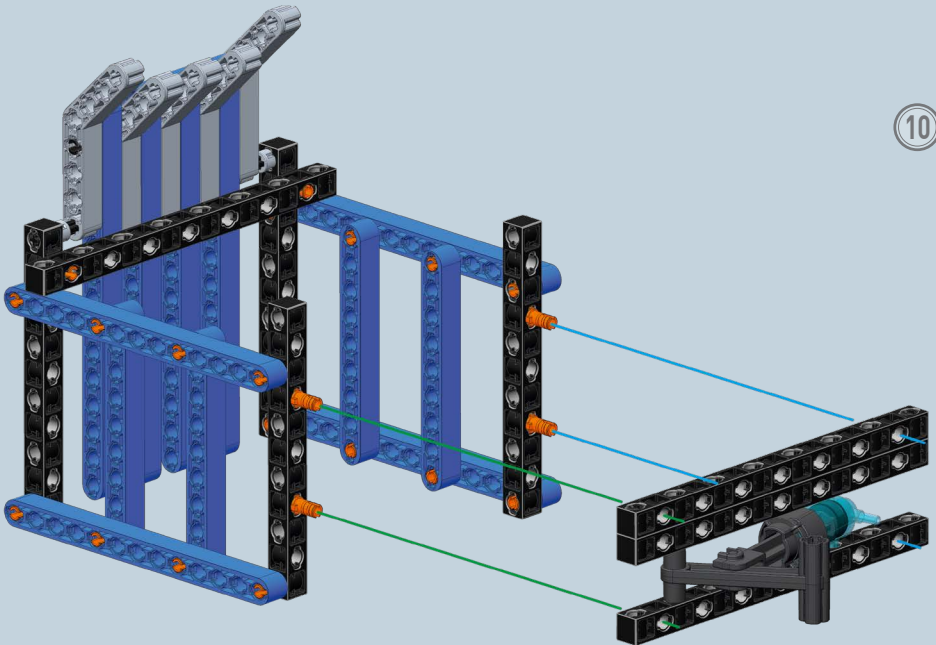

11

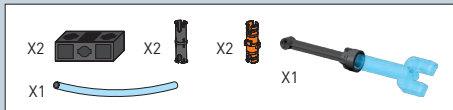
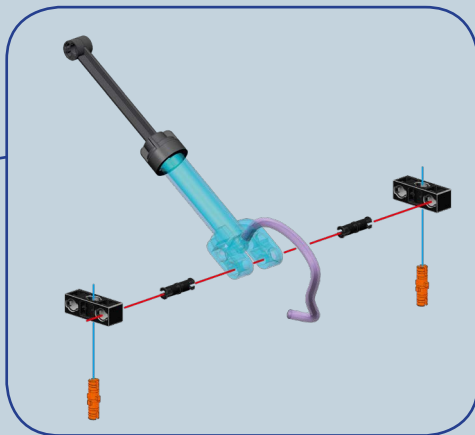
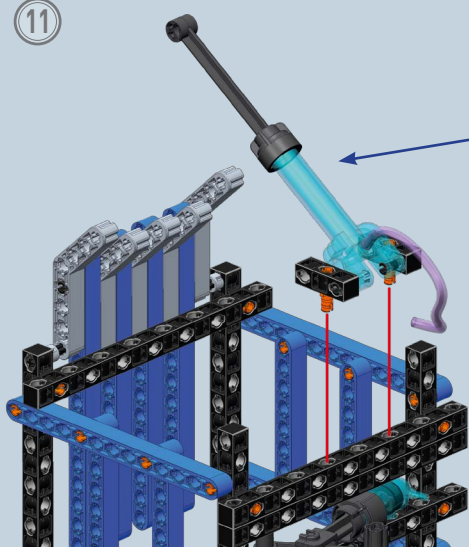

8,1 cm

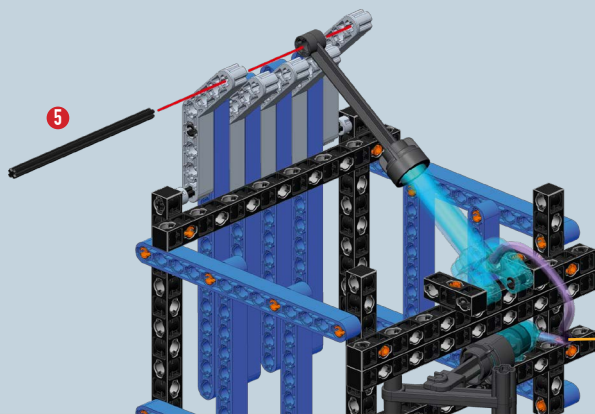

12

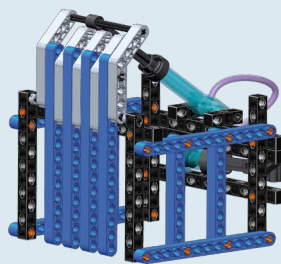
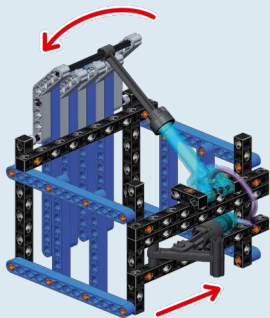
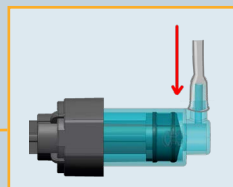

Modello finale

18 La pinza

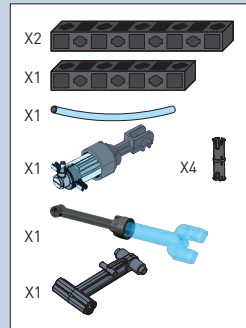
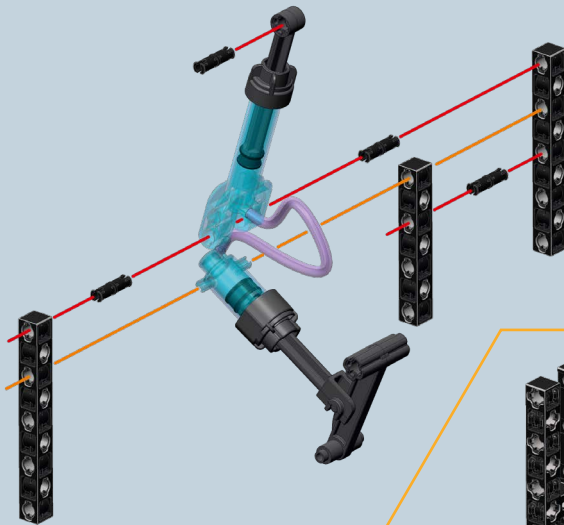
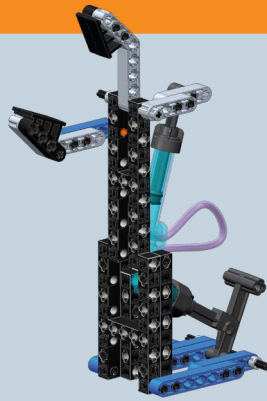



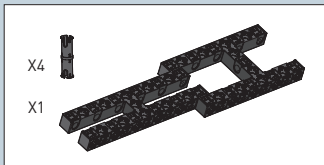
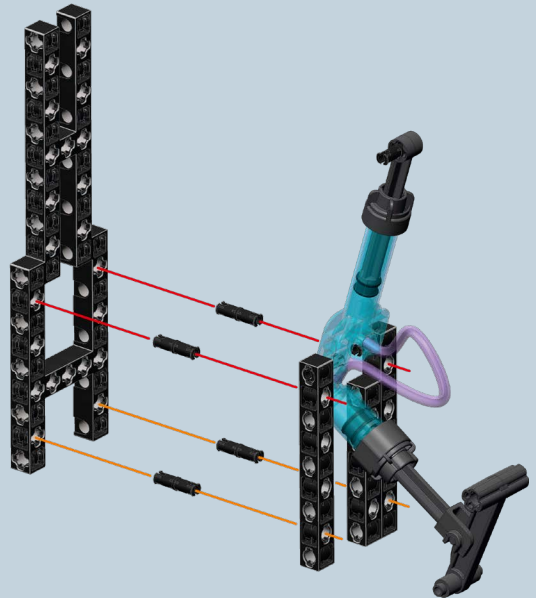

1

2

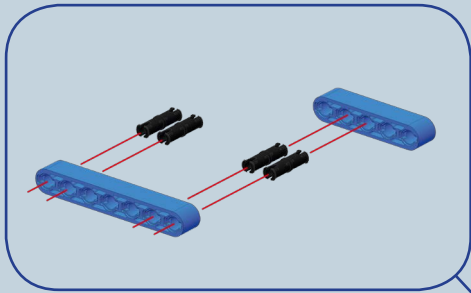

3



- X2  X6 
- X3  X3 

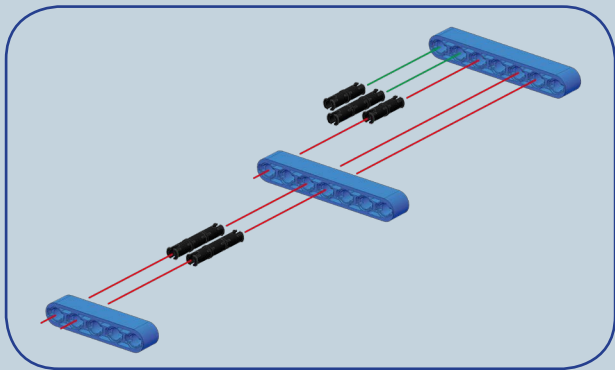
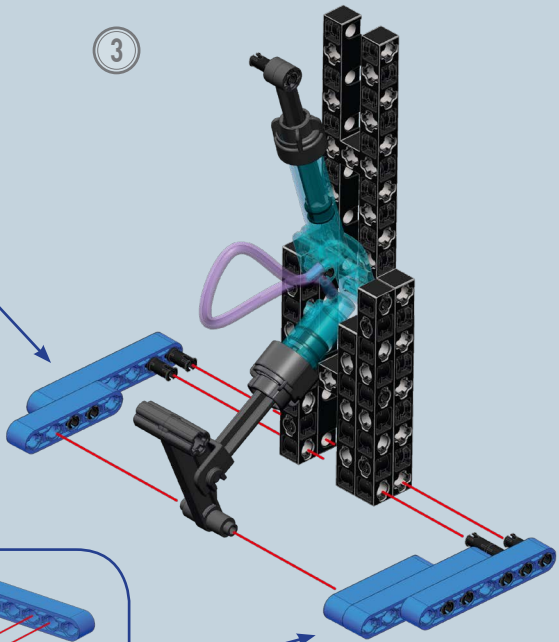

4

- X1   X2 

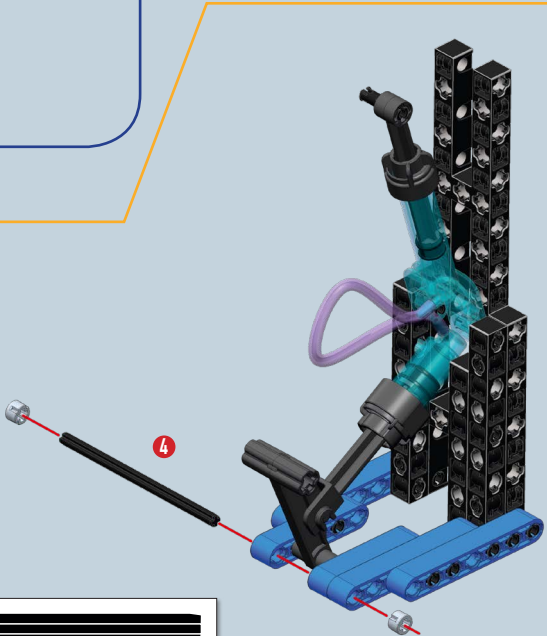

7,2 cm  

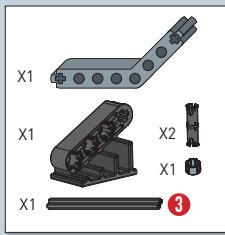

5

5,4 cm

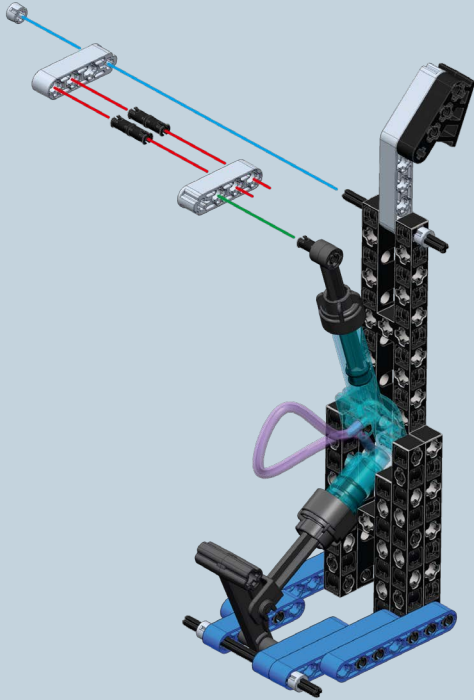
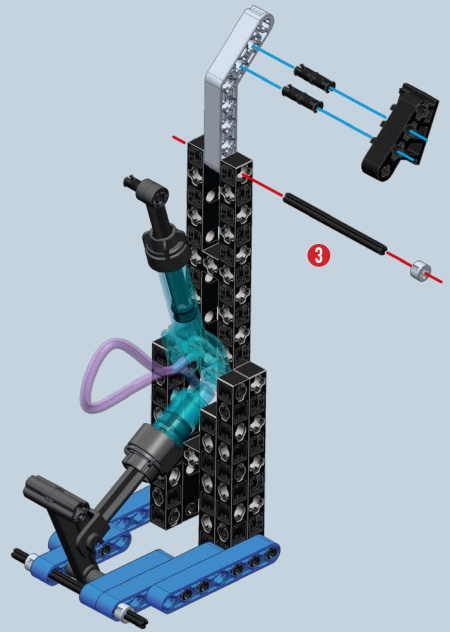

6

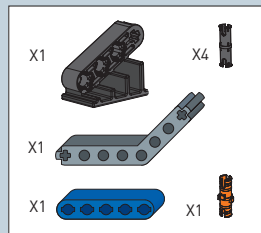
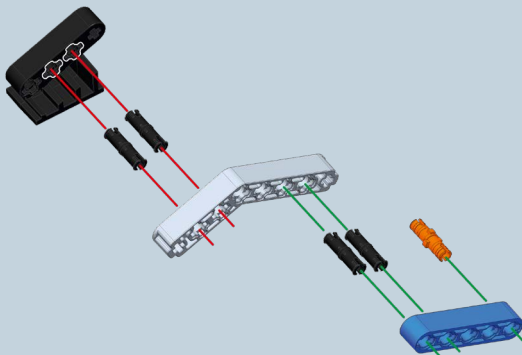
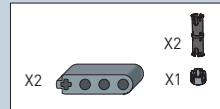

7

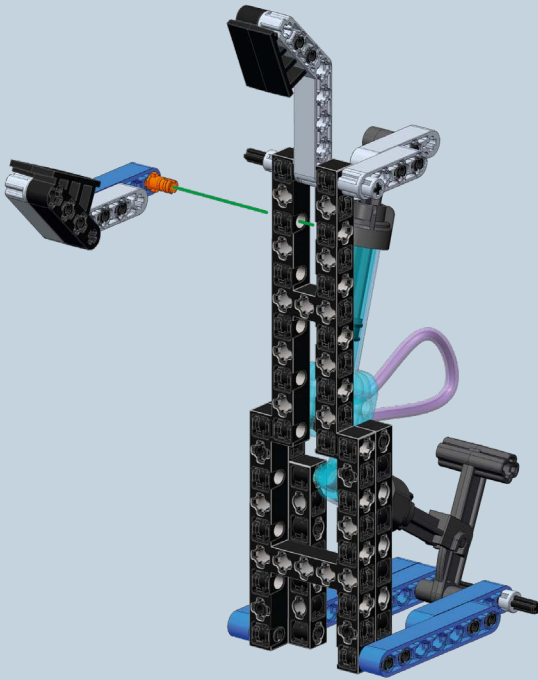

Modello
finale

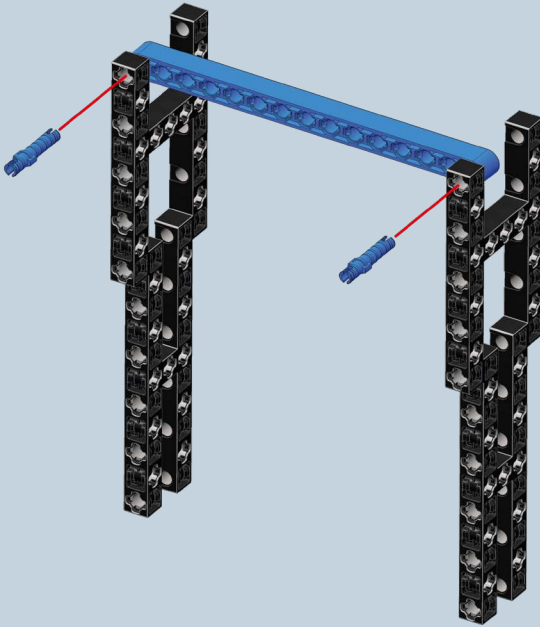
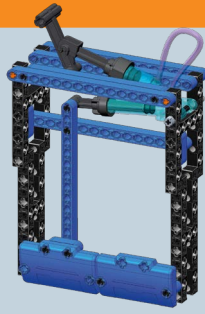

1

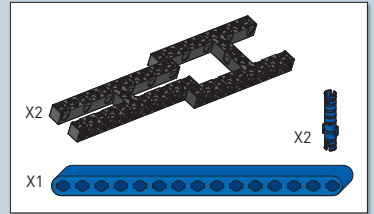

2

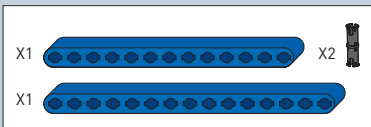
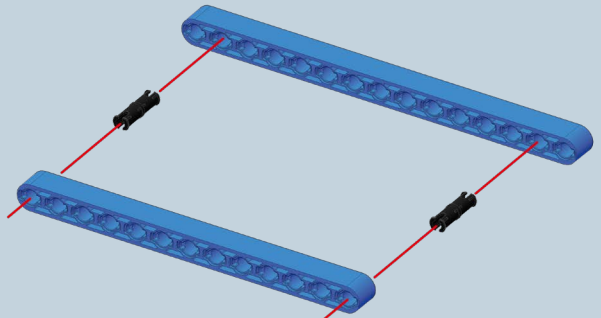

3

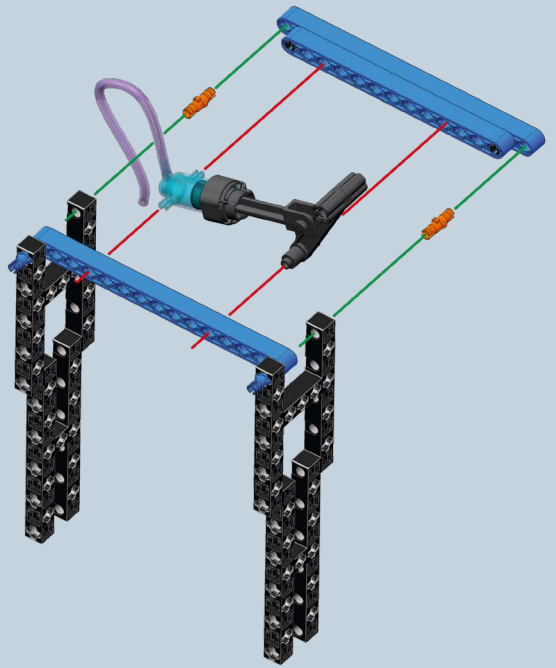
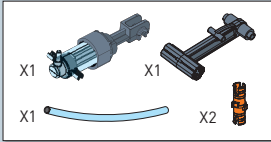

5,4 cm

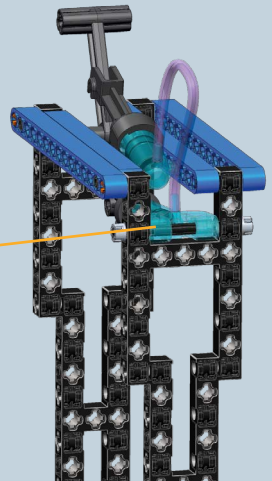
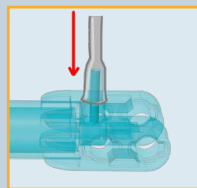
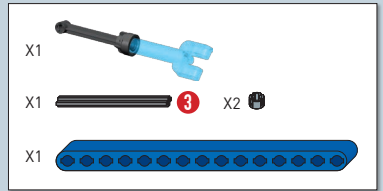
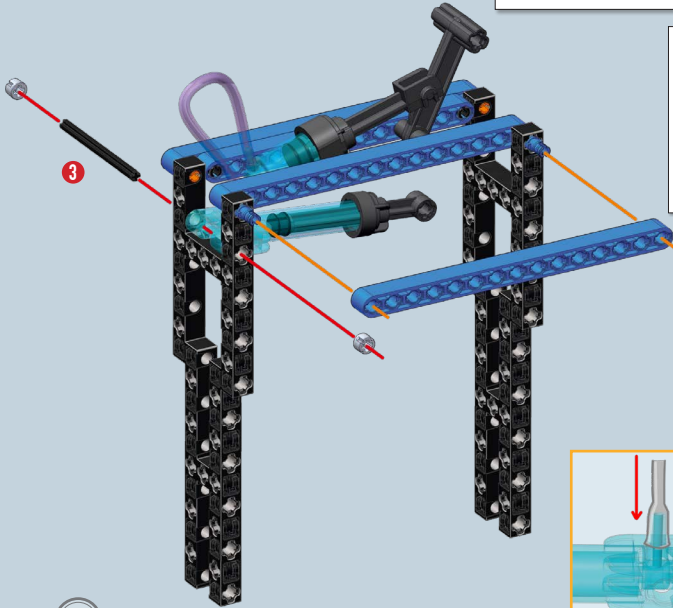

4

5

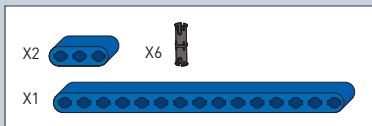
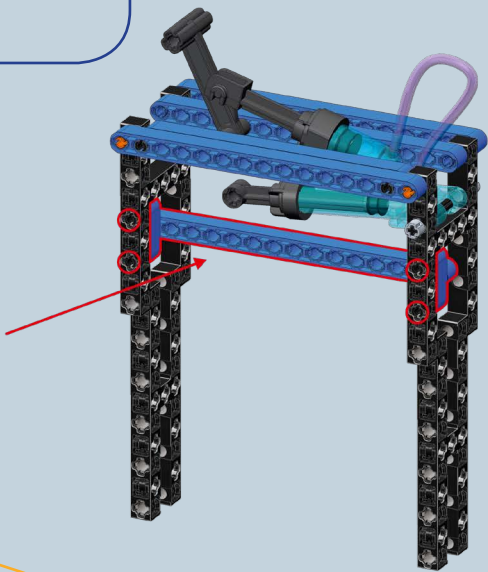
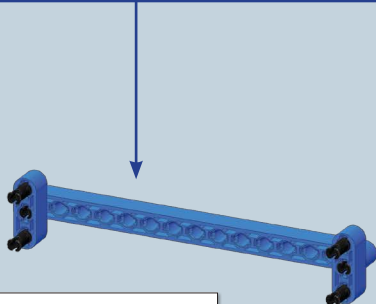
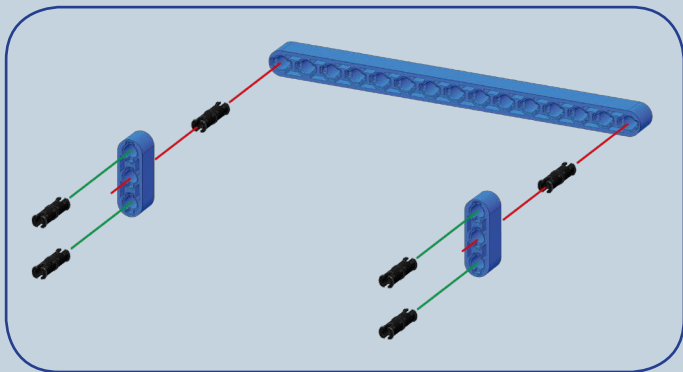

6

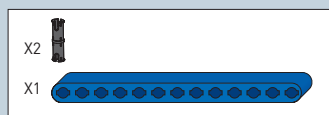
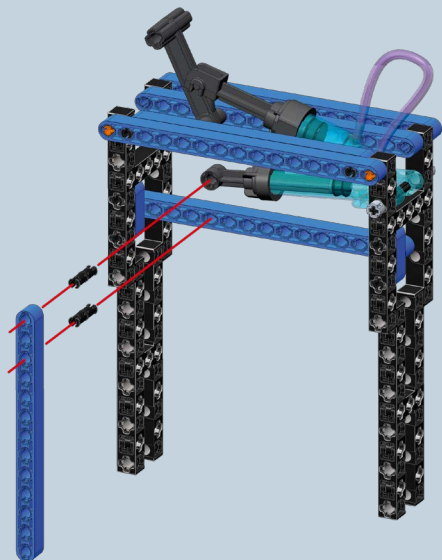

7

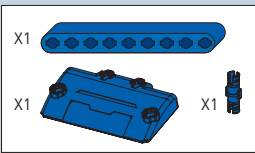
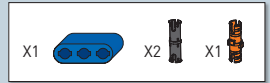
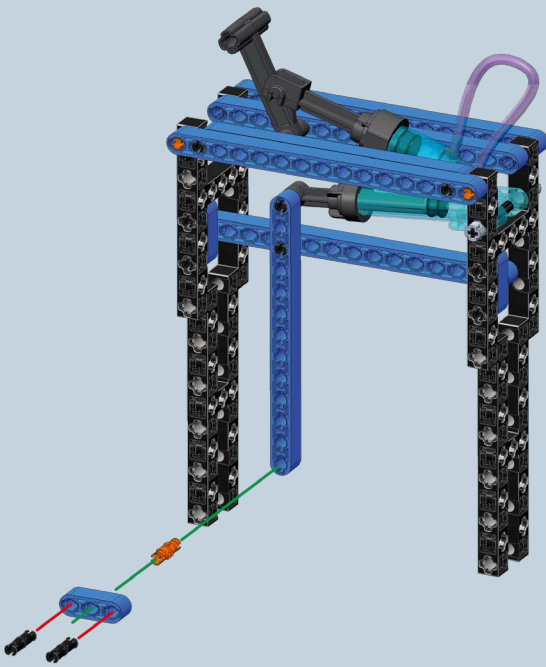

8

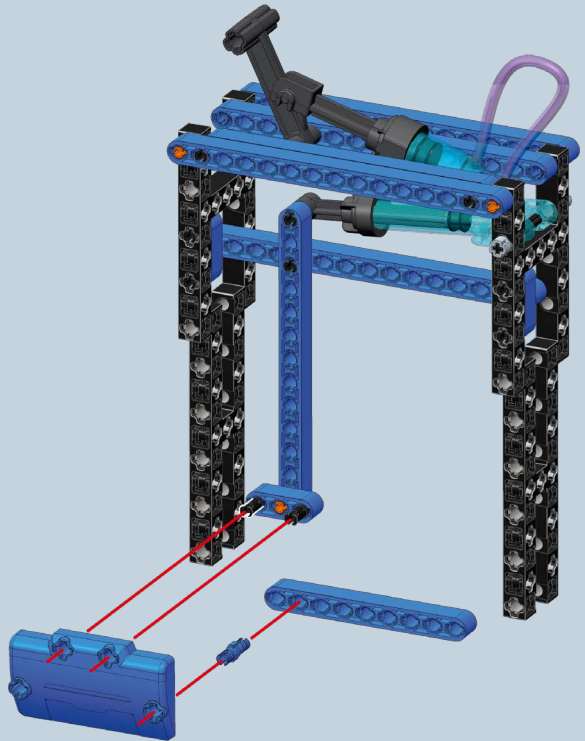

9

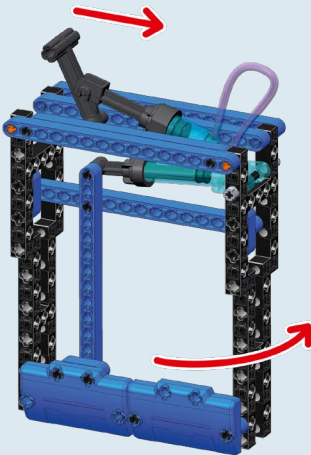
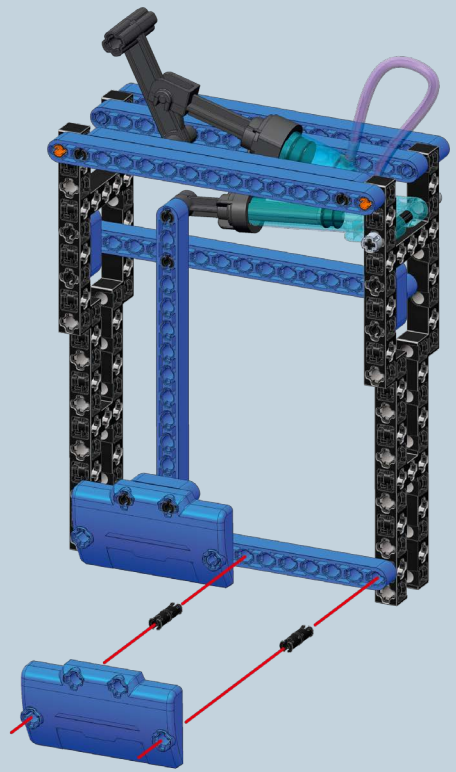
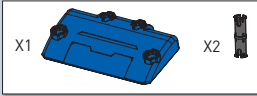

Modello
finale

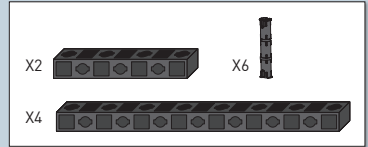
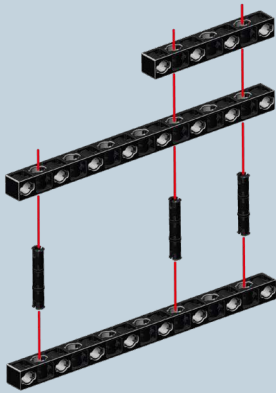
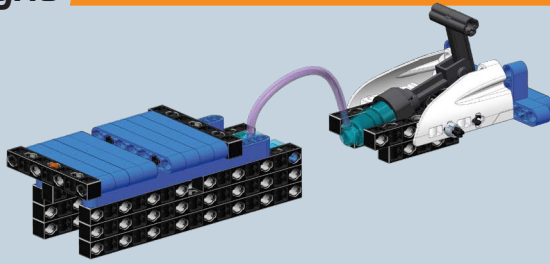

1

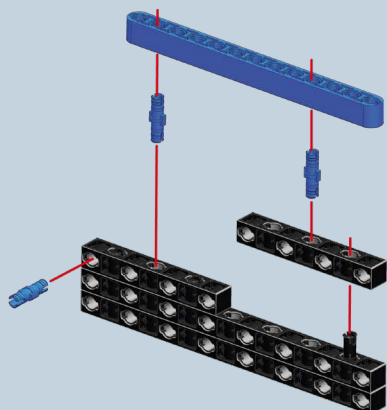
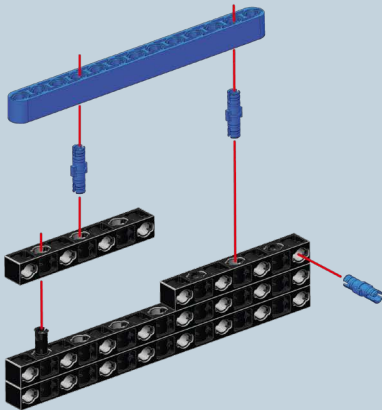
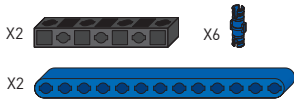

2

3

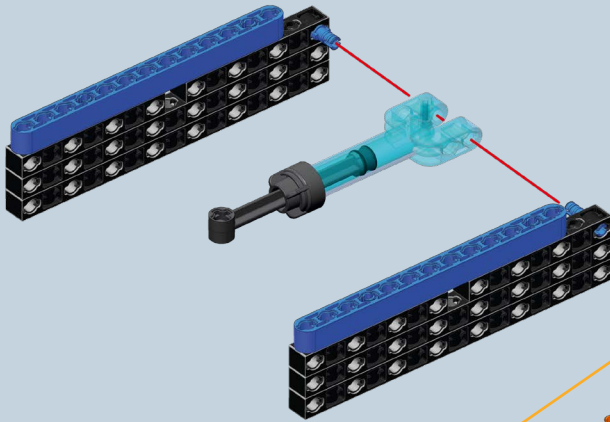



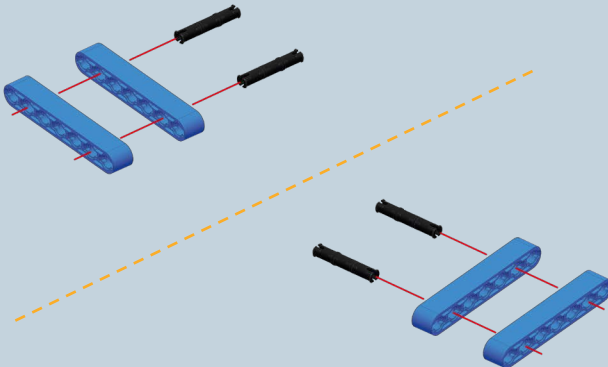
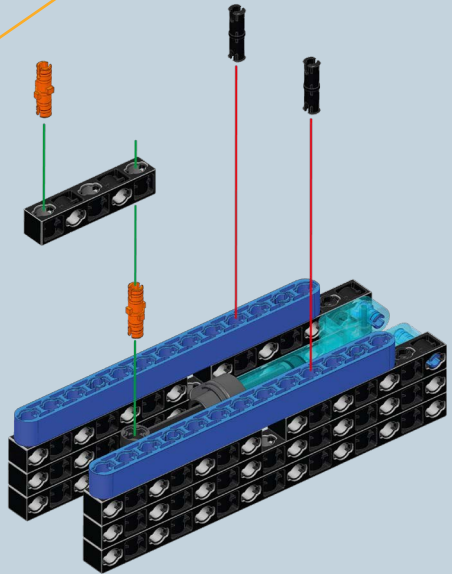
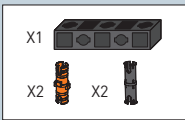

4

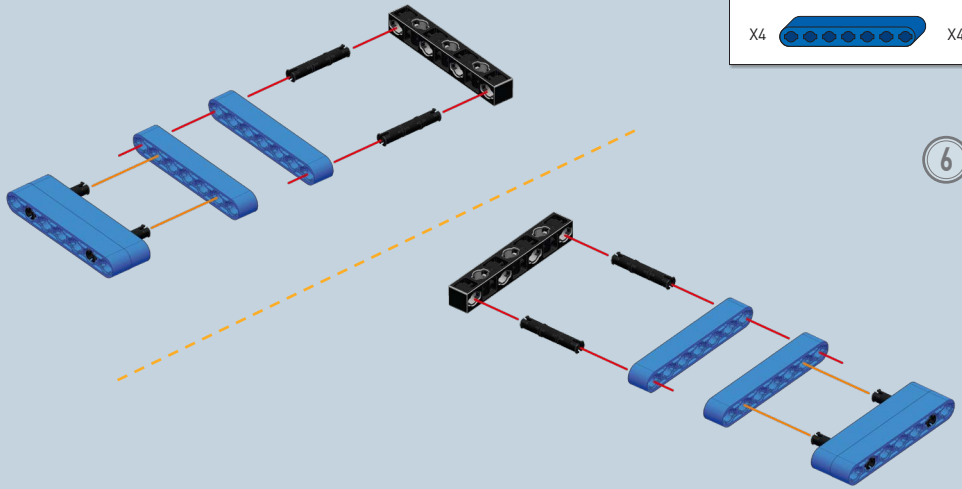

5





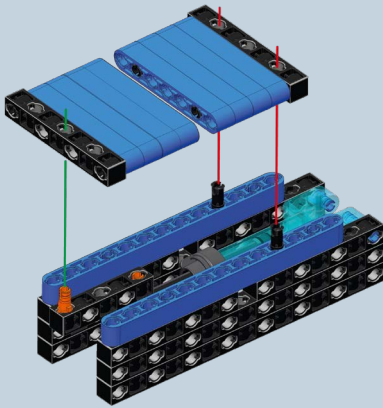

- X2   X4
- X4   X4

6



7

8

- X2   X6
- X2 
- X1 
- X1 

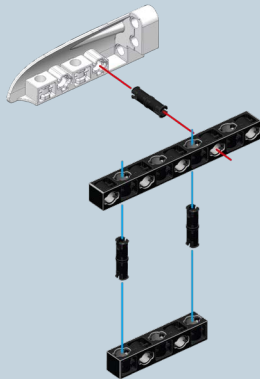

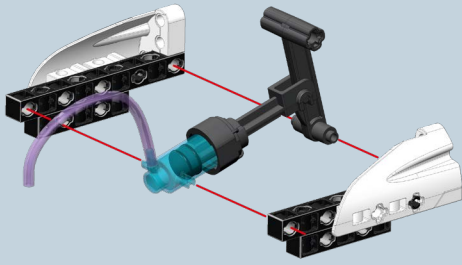

9

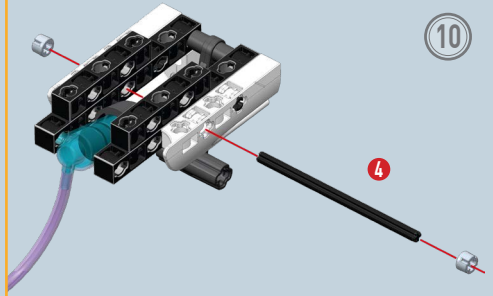
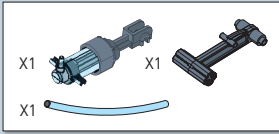

10



7,2 cm

11

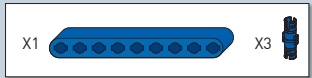
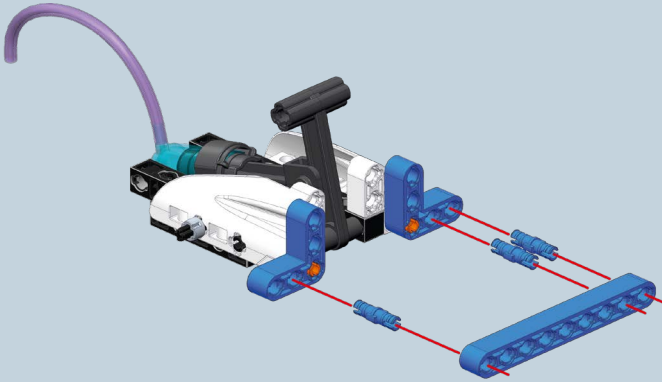
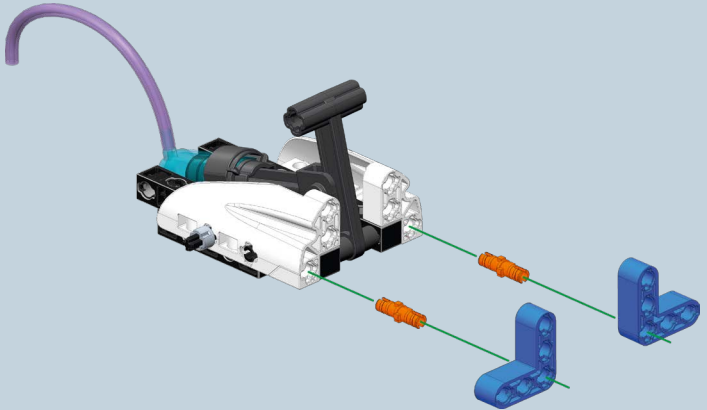

12

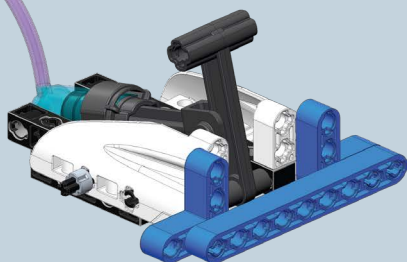
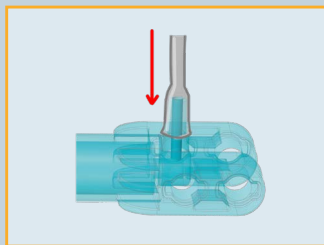
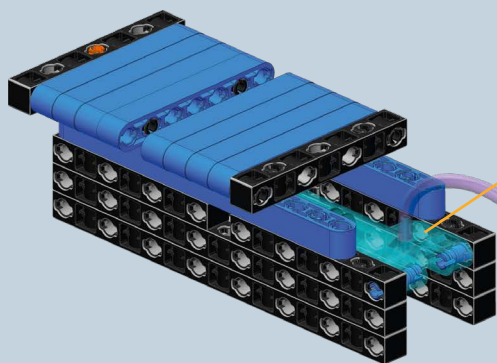

13

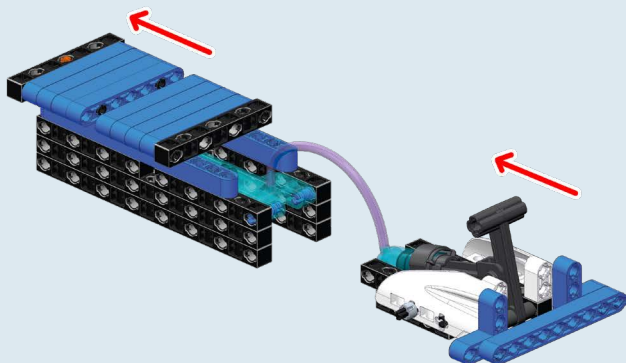
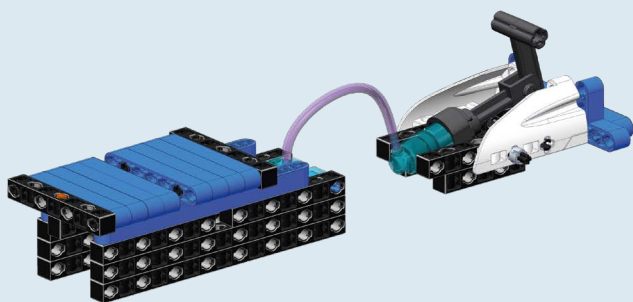

Modello
finale