

MECHANICS Laboratory

Constructions 1 to 30

- | | |
|---|--|
| <ul style="list-style-type: none"> 1 - Stacking two beams 2 - Stacking beams with two pegs 3 - Joining beams 4 - Stacking three beams 5 - Stacking beams perpendicularly 6 - Stacking with an angled beam 7 - Build a square with beams 8 - Stacking four beams 9 - Build a cuboid 10 - Build a simple bridge 11 - Assemble cogwheels on a rod 12 - Using pulleys 13 - Build a class 1 lever: pincers 14 - Build a class 2 lever: nutcracker 15 - Build a class 2 lever: wheelbarrow | <ul style="list-style-type: none"> 16 - Build a class 3 lever: tongs 17 - Build the lever's fulcrum and weight 18 - Assemble and test a mechanically advantaged lever 19 - Assemble and test a mechanically neutral lever 20 - Assemble and test a mechanically disadvantaged lever 21 - Assemble a set of scales 22 - Build and test a seesaw 23 - Assemble the test stand for reverse rotation 24 - Build and test forward rotation 25 - Assemble and test reciprocating motion 26 - Build and observe right-angle rotation 27 - Assemble a vertical gearbox 28 - Build a horizontal to vertical gearbox 29 - An ancient war machine: the battering ram 30 - Build a catapult |
|---|--|



WARNING

In order to ensure correct function of the electric motor, a small quantity of grease is added during the manufacturing process. As grease can melt at high temperatures, it may dirty the motor. However, it can simply be wiped off with a piece of kitchen paper or a napkin. The grease used is neither toxic nor hazardous.



V32815

WARNING!

Only for use by children aged 8 years and older.
Instructions for parents are included and have to be observed.

Read and keep this booklet for future reference.

TECHNOLOGIC

Made in Italy



Clementoni®

INSTRUCTIONS FOR SUPERVISING ADULTS: this toy is suitable for children aged 8 years and over. Adult supervision is recommended during assembly and when handling and installing electrical components.

REMOVING AND INSTALLING THE BATTERIES

Make sure that the equipment is switched off.

- 1 Use a screwdriver to loosen the screw that secures the cover to the battery chamber.
- 2 Remove the old batteries.
- 3 Insert (4 x 1.5V AA/LR6). Make sure the positive and negative ends of the batteries match the direction indicated on the battery chamber.
- 4 The batteries must be inserted by an adult.
- 5 Close the battery chamber and tighten the screw.
- 6 Make sure that the equipment is working properly.

INSERTING THE BATTERIES

Ask an adult for help!

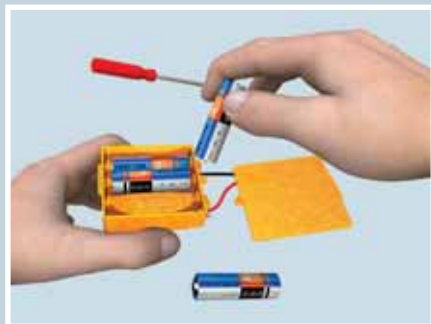
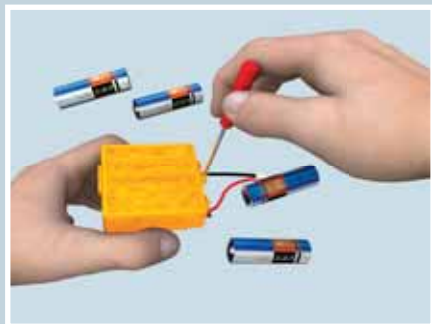

Power supply: 6V DC

Batteries: 4 x 1.5V AA/LR6

Batteries not included.

OTHER RECOMMENDATIONS:

- Batteries are dangerous if swallowed; keep away from children.
- Always remove batteries prior to long-term storage.
- Do not try to open the batteries.
- Do not throw batteries into a fire.

INSTRUCTIONS FOR CORRECT USE OF PRODUCTS WITH REPLACEABLE BATTERIES

WARNING!

- Batteries must be installed by an adult.
- The + and - symbols on the batteries must be lined up correctly.
- Old batteries must be removed from the product.
- The power terminal block must not be short-circuited.
- Never touch the contacts inside the battery case, as this could cause a short circuit.
- The rechargeable batteries must be removed prior to being charged. Only recharge under adult supervision.
- Never attempt to recharge non-rechargeable batteries.
- Different types of batteries or new and used batteries should not be used at the same time.

INSTRUCTIONS FOR BATTERY DISPOSAL

 The symbol indicates that dead batteries must be disposed of in accordance with current regulations for waste disposal. Chemical symbols for mercury (Hg), cadmium (Cd) and/or lead (Pb) which appear below the crossed out wheellie bin symbol indicate that there is a significant percentage of the relative substance in the battery. These substances are highly damaging to the environment and human health. The correct disposal of batteries allows their isolation and the targeted treatment of harmful substances, and allows recycling of precious primary materials, reducing negative effects on persons and the environment. The disposal of worn-out batteries in landfills or the environment significantly increases the risk of water pollution. Pursuant to European Directive 2013/56/EU, it is prohibited to dispose of batteries and accumulators as urban waste and consumers are obliged to participate in separated waste collection so as to facilitate the treatment and recycling of the same.

HOW TO DISPOSE OF BATTERIES:

Discharge the batteries completely by leaving on the product until the batteries have fully run out. Remove the batteries from the product before disposal. Dispose of all batteries in accordance with current regulations, by using the appropriate containers at an authorised recycling centre or by returning them to the shop where they were purchased. Returning them is free! Penalties are applied for incorrect disposal.

INSTRUCTIONS FOR THE DISPOSAL OF ELECTRICAL AND ELECTRONIC DEVICES SUBJECT TO SEPARATE WASTE DISPOSAL

IMPORTANT! The crossed out wheelee bin symbol  indicates that in European Union member states (Dir. 2012/19/EU) and in those that adopt separated waste collection systems, all components of the product marked by this symbol (or indicated as such in the product instructions) are subject to separated waste collection laws at the end of their life. It is prohibited to dispose of such components as mixed urban waste.

HOW TO DISPOSE OF ELECTRICAL AND ELECTRONIC DEVICES:

- It is mandatory to separately collect those components marked by the symbol  (or indicated as such in the relevant documentation) and deliver them to authorised recycling centres for the purposes established, or where possible, to return the product for disposal back to the shop when a similar product is purchased, or for free in the event the external dimensions of the component are less than 25 cm.
- Users of the product play a critical role in ensuring the correct disposal of electrical and electronic equipment that has reached the end of its life. It is therefore important for each user to be aware of their role and to always dispose of electrical/electronic waste in accordance with current legislation, thereby contributing to the correct management of waste and encouraging its reuse, recycling and/or recovery.

WARNING!

Components marked by the symbol  contain substances that are harmful to the environment and human health. It is therefore prohibited to dispose of them as mixed urban waste or together with other domestic waste. Incorrect disposal may result in damage to the environment and may be punished by the law. These components should not be used improperly. In particular, it is prohibited to remove the electrical and electronic parts from the toy or use the toy if damaged. These actions could cause health hazards.

N.B.: The above information only relates to the parts of the toy marked with the prohibitive symbol  (or those parts indicated in the information leaflet as being subject to this restriction).

Other product components (cards, accessories, etc.) and their packaging are not subject to the above described indications and must be disposed of according to the methods provided for by current standards. These other components do not need to be delivered to authorised recycling centres for electrical and electronic equipment or returned to the shop when a new product is purchased.

Domestic users (non-professional) are invited to contact their local retailer, the public waste disposal authorities or the Customer Service Department of CLEMENTONI S.p.A. (Tel. +39 071 75811; fax +39 071 7581234; e-mail: info@clementoni.it) for further information about the correct way to dispose of the product.

 Registered on the electronic and electrical manufacturers' register: **REGISTRATION IN PROGRESS.**

INTRODUCTION

The MECHANICS LABORATORY is a construction toy system that enables children to create all kinds of machines, from simple models like pincers, tongs and carts, to more complex assemblies like cars and cranes with electric motors.

The illustrated booklet consists of three parts and describes all the steps necessary to build each model. It is essential to refer to this booklet, starting with Part I and then moving on to Part II and finally Part III.



A class 1 lever: pincers



Car with manual gearbox
and electric motor

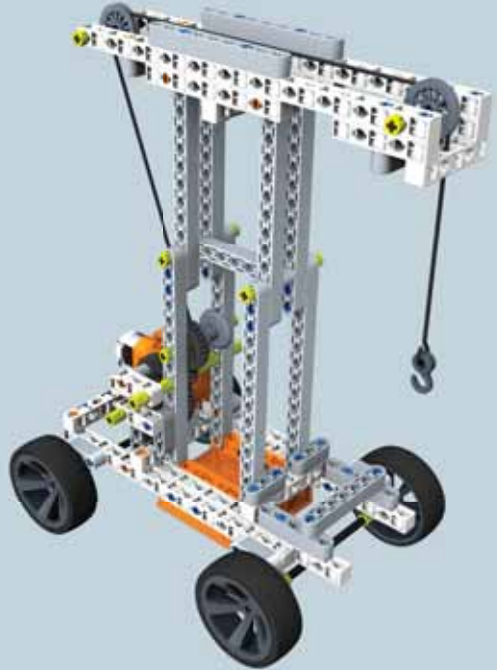

Crane with electric motor

Children can use their inventiveness to create their own realistic models which follow the essential principles of physics and mechanics.

The child's developing mind, aided by their imagination, will seek to understand the relationships and distances between the various parts as they build the model, contributing to the child's blossoming creativity.

The activities have varying degrees of difficulty and are suitable for children aged 7-8 years and over, depending on the child's own individual abilities.

TABLE OF CONTENTS

Safety advice	page	2
Instructions for correct use of products with replaceable batteries	page	2
Introduction	page	4
Parts list	page	5
How the pieces are made	page	5
Characteristics of the kit components	page	5
Activities	page	7

PARTS LIST



Double beam 15 holes 4 pcs

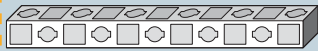

Double beam 11 holes 4 pcs

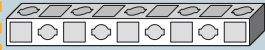

Double beam 9 holes 4 pcs

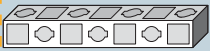

Double beam 7 holes 4 pcs



Double beam 5 holes 4 pcs



Double beam 3 holes 4 pcs

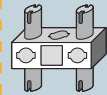

Beam with pins 4 pcs

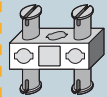

Beam with pegs 4 pcs

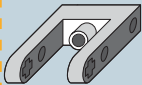

Right angle gearbox 2 pcs

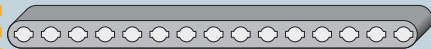

Single beam 15 holes 4 pcs



Single beam 13 holes 4 pcs

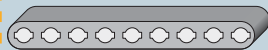

Single beam 9 holes 4 pcs

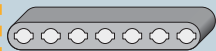

Single beam 7 holes 4 pcs

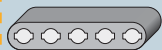

Single beam 5 holes 4 pcs



Single beam 3 holes 4 pcs

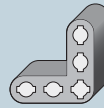

Angled beam (top) 4 pcs

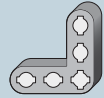

Angled beam (bottom) 2 pcs



Short single peg 32 pcs



Long single peg 32 pcs



Short double peg 32 pcs



Long collar 24 pcs



Short collar 24 pcs



Rod 1 2.7 cm long 2 pcs



Rod 2 3.6 cm long 4 pcs



Rod 3 5.4 cm long 10 pcs



Rod 4 7.2 cm long 2 pcs



Rod 5 8.1 cm long 2 pcs



Rod 6 11.7 cm long 2 pcs



Cogwheel with 10 teeth 1 pc



Cogwheel with 18 teeth 5 pcs



Cogwheel with 26 teeth 1 pc



Cogwheel with 41 teeth 1 pc



Spool 1 pc



Pulley 4 pcs



Hook 1 pc



Crank 2 pcs



Steering wheel 1 pc



Wheel rim 4 pcs



Large tyre 4 pcs

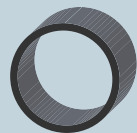

Car body 2 pcs

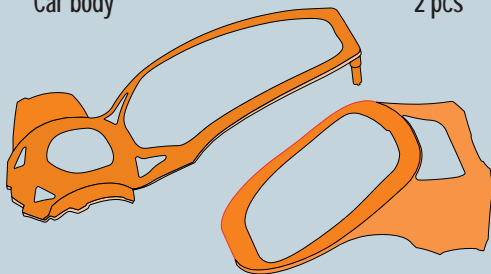

String (150 cm long) 1 pc



Electric motor 1 pc

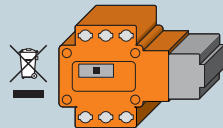

Battery compartment 1 pc

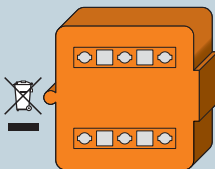

Elastic band 3 pcs



Small tyre (for pulley) 4 pcs



Toothed rod 1 pc



ACTIVITIES

Before you start building, observe carefully how the parts of the kit are made!
If you get stuck, ask an adult for help.

WARNING!

- Take care when detaching the parts from the plastic frame. Use your hands to gently rotate each element. Never just pull them off.
- You will find that the rods fit into the various different parts, such as the collars and cogwheels etc., with varying degrees of resistance and tightness. Try adjusting the position of the rod in the hole to achieve a better fit, if necessary.

Warning! In the assembly steps, different icons indicate when the model needs to be rotated, when to tighten the pieces, when to use a beam with pins or one with pegs.

• Key



Rotate the model.



The pieces need to be tightened

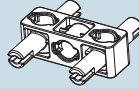

Beam with pins

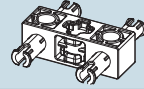

Beam with pins

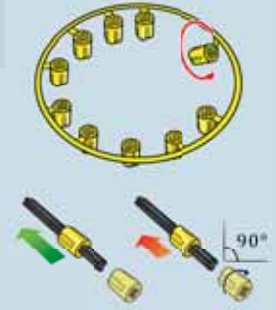

1 Stacking two beams

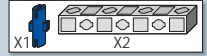
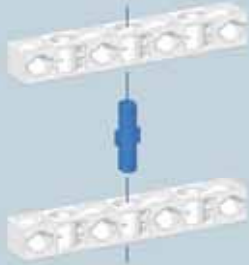

Assembled beams

2 Stacking beams with two pegs

The two pegs make the construction very strong!

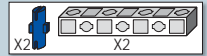
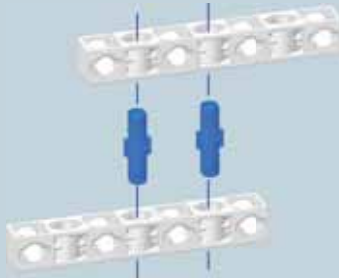

Assembled beams

3 Joining beams

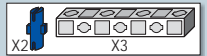
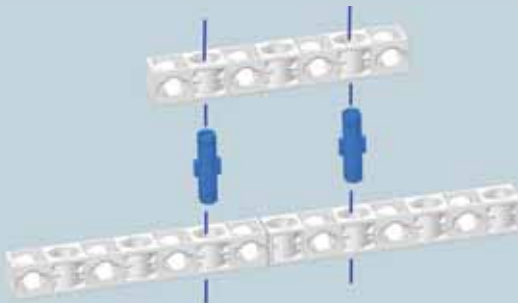

Assembled beams

4 Stacking three beams

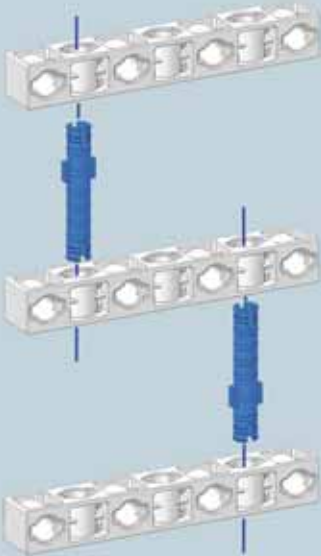

Assembled beams

5 Stacking beams perpendicularly

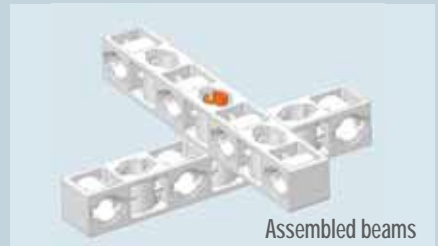
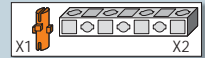
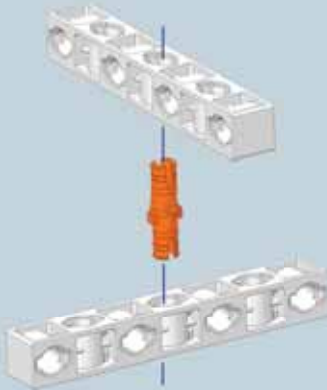

Assembled beams

6 Stacking with an angled beam

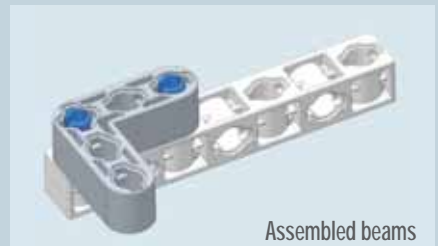
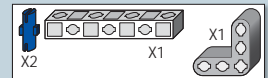
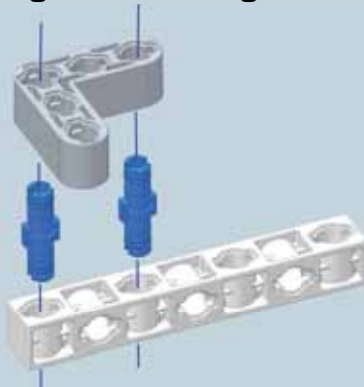

Assembled beams

7 Build a square with beams

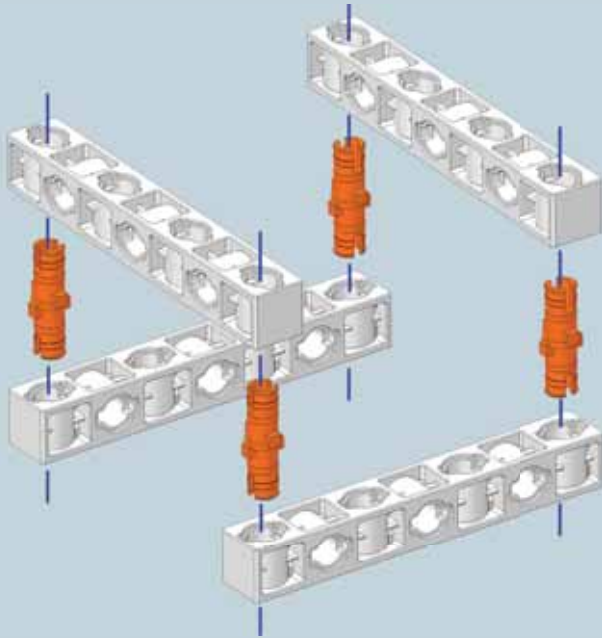

Final assembled model

8 Stacking four beams

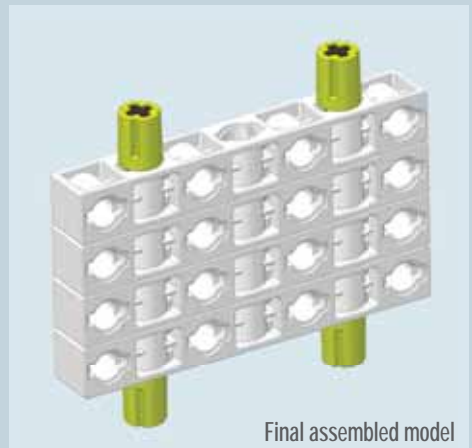
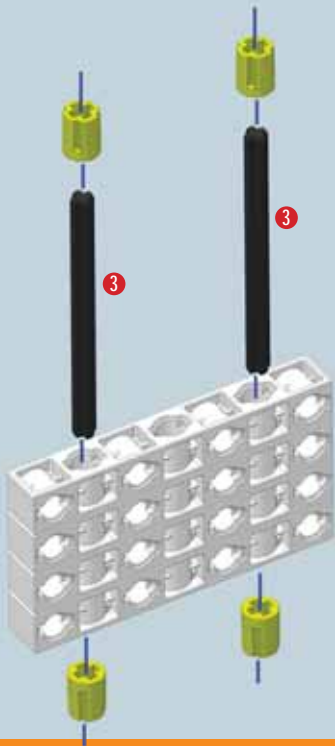

Final assembled model



9 Build a cuboid



1

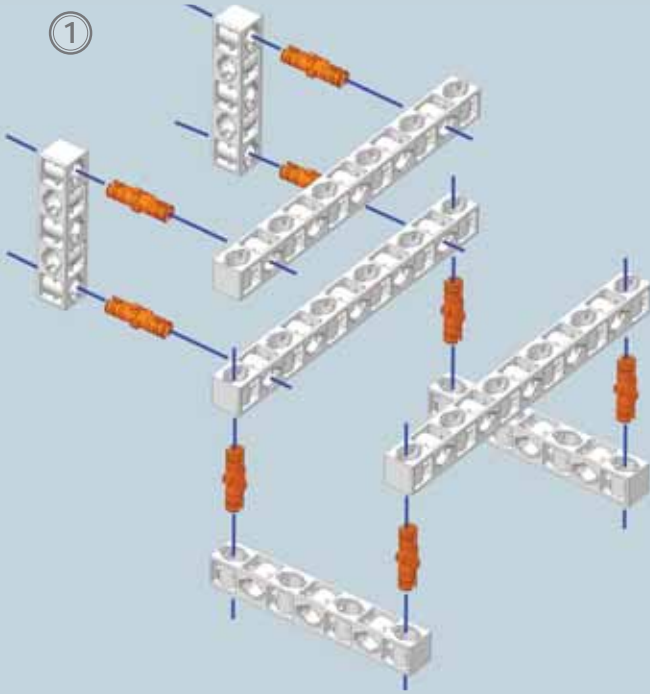

X3	
X2	
X8	
X2	

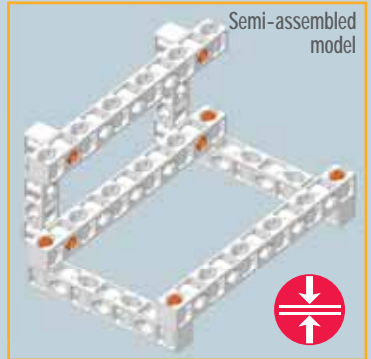

Semi-assembled model

2

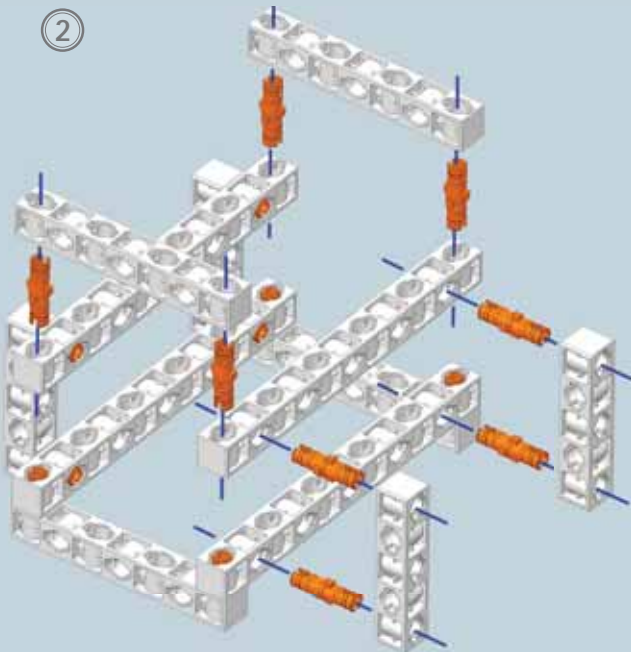

X1	
X2	
X8	
X2	



Final assembled model

10 Build a simple bridge

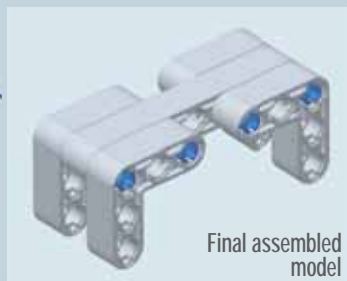
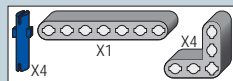
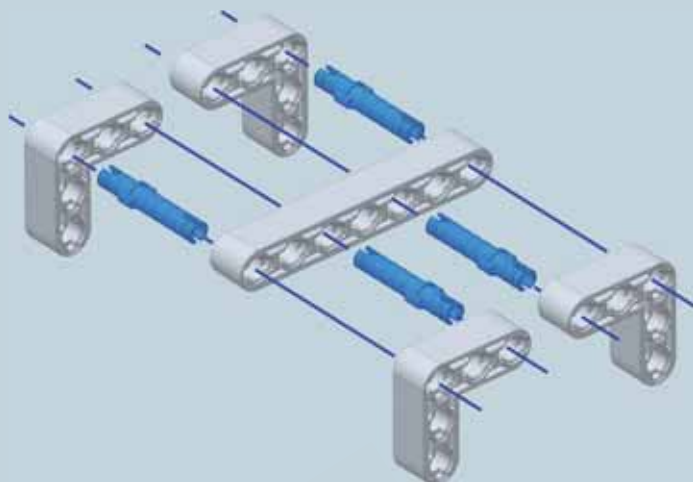

11 Assemble cogwheels on a rod

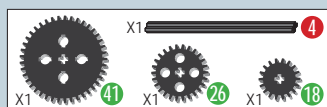
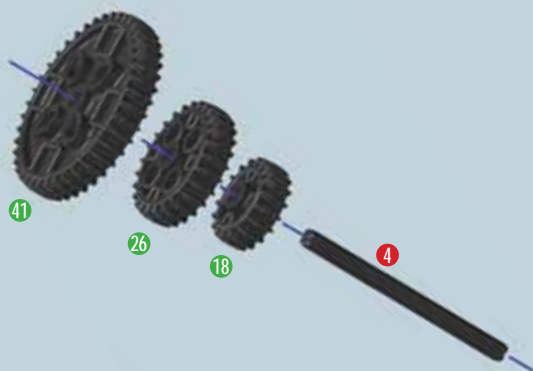

Try it out as a spinning top!

12 Using pulleys

Create a pulley system using the pulley and string.

Transform the pulley into a wheel with the elastic band.

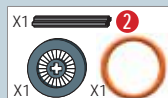

Since ancient times humans have made use of many of these mechanisms to increase our strength and accomplish much greater things than we could with our bodies alone.



Wheelbarrow

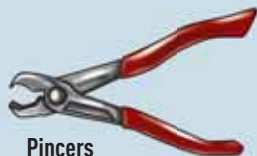

Pincers

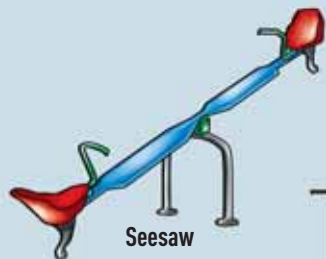

Seesaw



Nutcracker



Scales



Pulley

A simple machine is a mechanical device that can be used to balance and overcome **RESISTANCE** (weight, resistance force = **R**) with **EFFORT** (human strength=**E**).

LEVERS

A lever is a simple machine that is made up of a rigid bar which can rotate around a fixed point called the fulcrum.

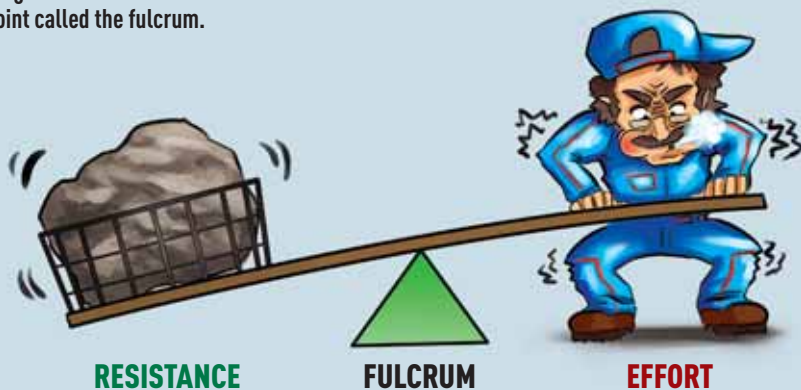

- Pairs of levers also obey this principle.
- Levers are classified by the relative positions of the **EFFORT**, **RESISTANCE** and **FULCRUM**.

13 Build a class 1 lever: pincers

1

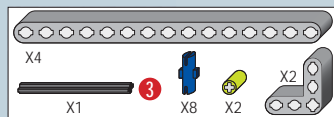
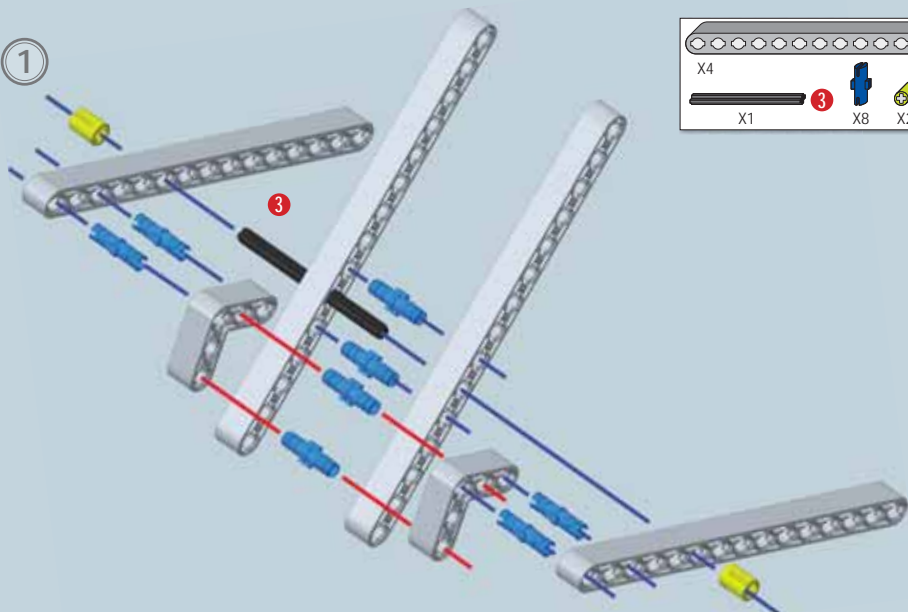

2

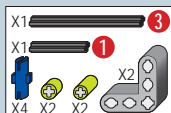
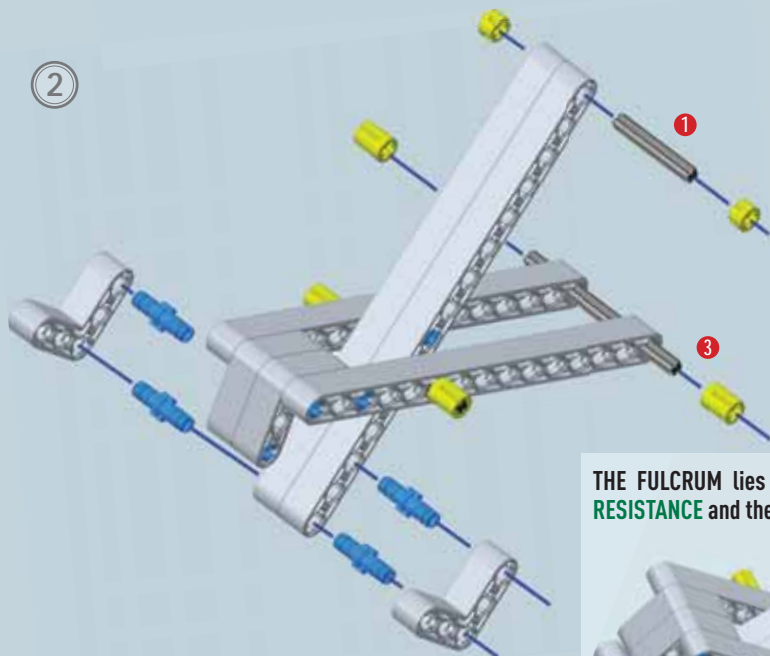

THE FULCRUM lies between the RESISTANCE and the EFFORT.

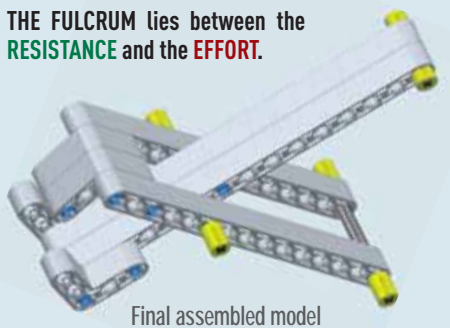

Final assembled model

1:1

1:1

14 Build a class 2 lever: nutcracker

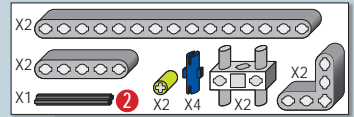
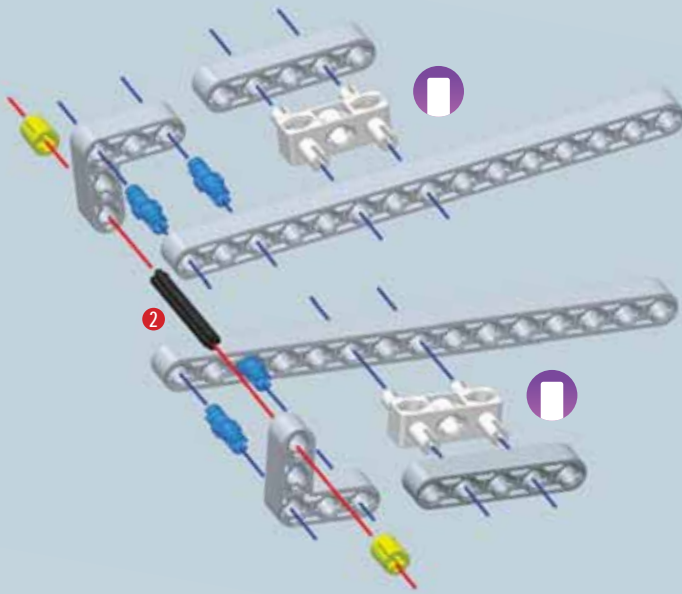

The **RESISTANCE** lies between the **EFFORT** and the **FULCRUM**.

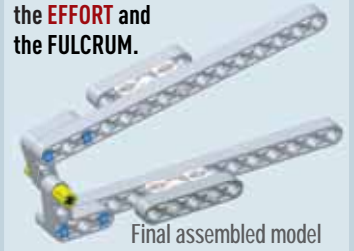

15 Build a class 2 lever: wheelbarrow

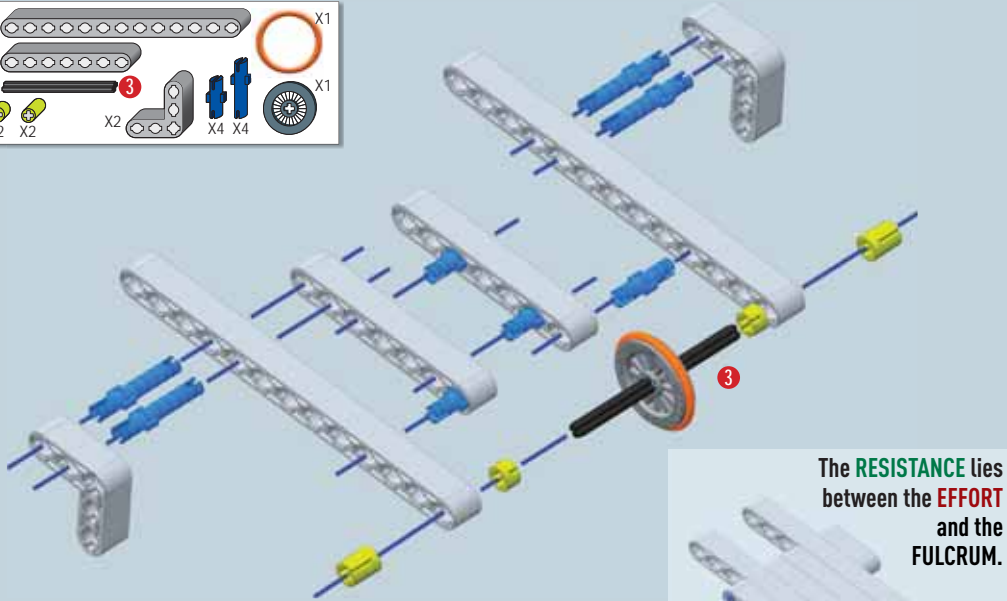
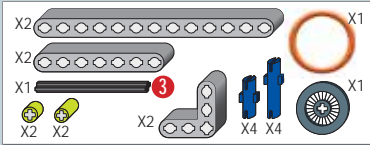

The **RESISTANCE** lies between the **EFFORT** and the **FULCRUM**.

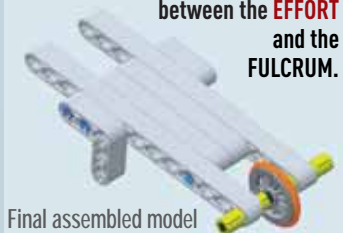

16 Build a class 3 lever: tongs



1

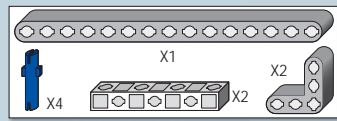
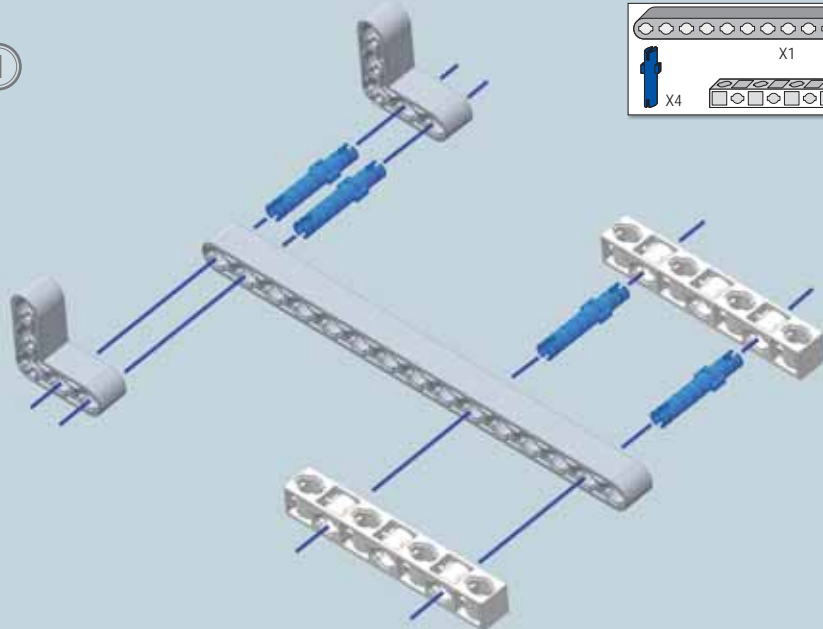

2

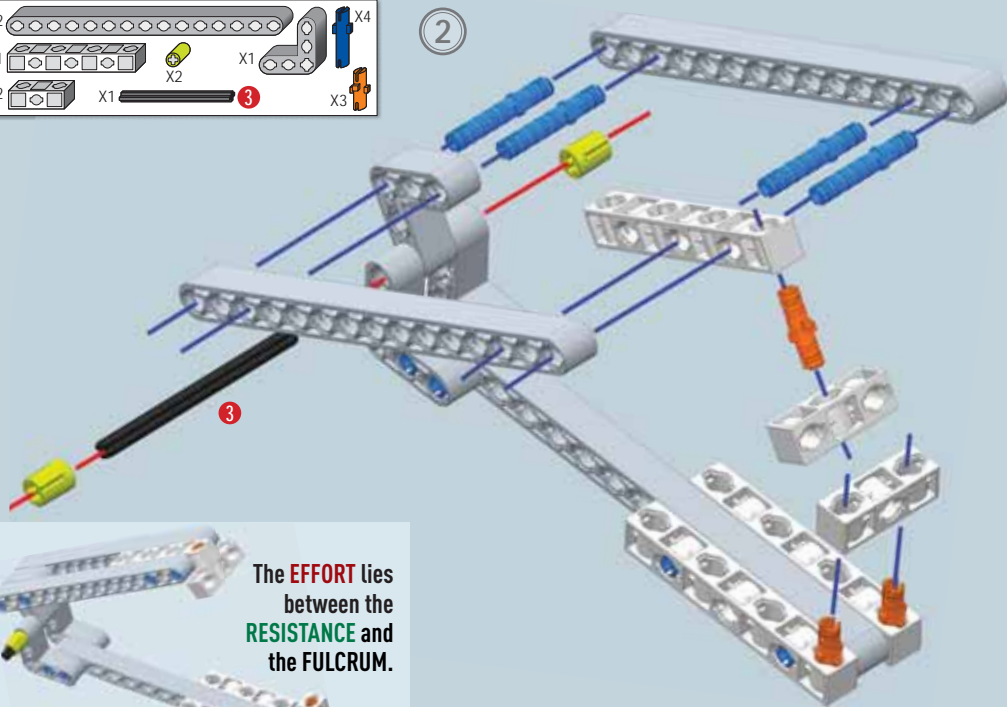
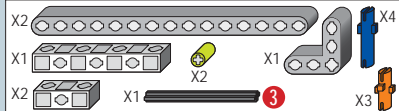

The **EFFORT** lies between the **RESISTANCE** and the **FULCRUM**.

Final assembled model



Scientific analysis: mechanical advantage with levers

A lever is a simple machine built by man designed to reduce the force needed to do work. There are two forces that are applied to the bar: one is the **EFFORT** and the other is the **RESISTANCE**. A lever provides a **MECHANICAL ADVANTAGE**. You can calculate a lever's mechanical advantage by considering the length of the arms of the **EFFORT** and **RESISTANCE** forces. The length of the arms corresponds to the distance from the fulcrum to the point where the force is applied.

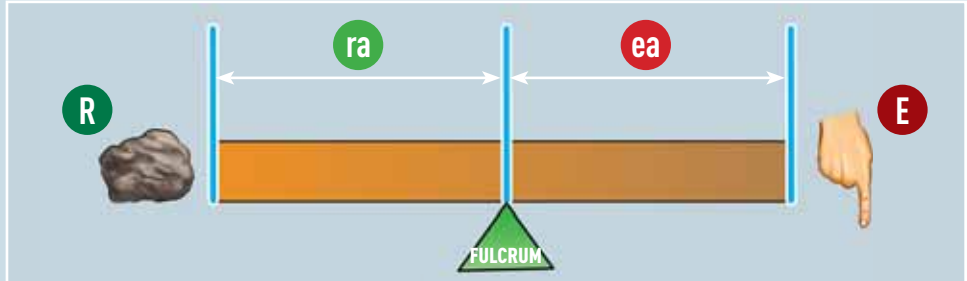

Key:

- ea = EFFORT arm
- ra = RESISTANCE arm
- E = EFFORT force
- R = RESISTANCE force

CONDITIONS FOR EQUILIBRIUM $ra \times R = ea \times E$

MECHANICAL ADVANTAGE $A = R / E$

ASSEMBLE AND TEST THE LEVERS

17 Build the lever's fulcrum and weight

1

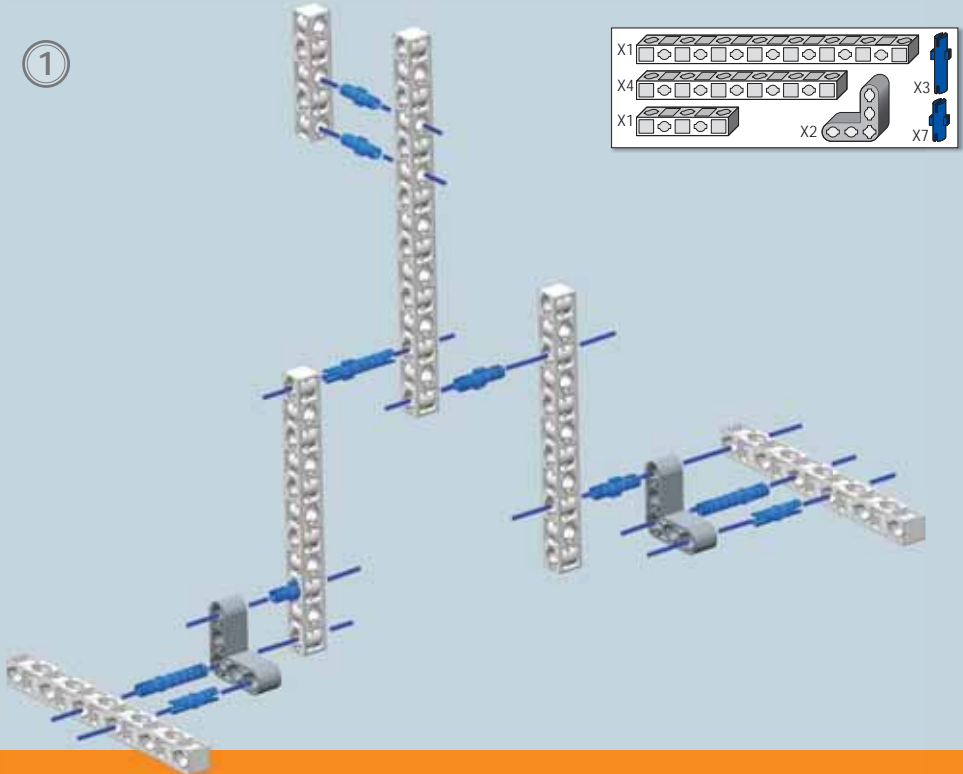

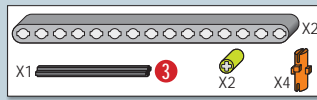
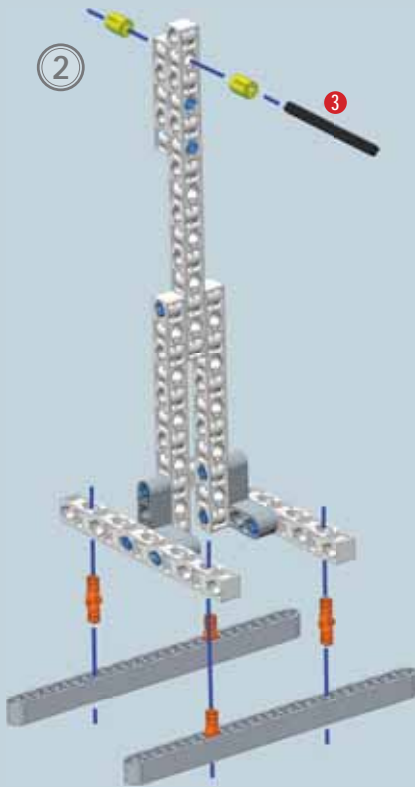

ASSEMBLING THE WEIGHT

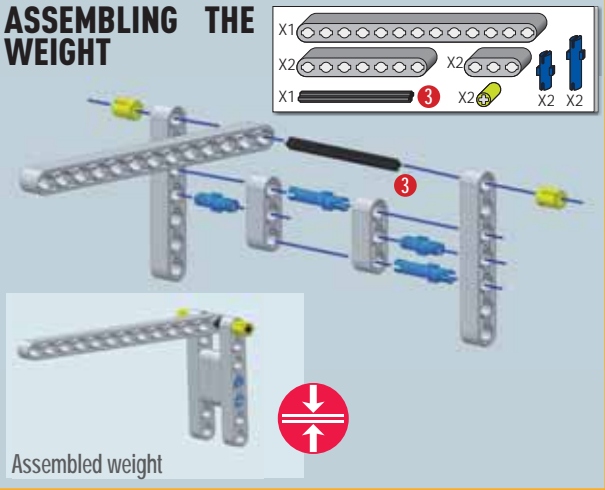

In Activities 18-19-20 try moving the fulcrum and then applying downward pressure to the EFFORT arm with your hand to see the differences between the levers.

18 Assemble and test a mechanically advantaged lever

Find the equilibrium of this type of mechanical device: position the weight (RESISTANCE) on one side of the lever and gently press down with your hand (EFFORT) on the other side.

Note the position of the fulcrum!

- The **EFFORT** arm is longer.
- The **EFFORT** is less than the **RESISTANCE**.

TRY IT OUT!

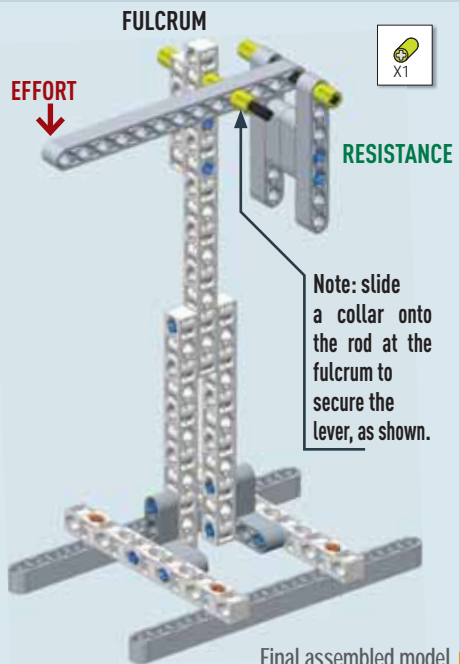

19 Assemble and test a mechanically neutral lever

Find the equilibrium of this type of mechanical device: position the weight (RESISTANCE) on one side of the lever and gently press down with your hand (EFFORT) on the other side.

Note the position of the fulcrum!

- The arms are the same.
- The **EFFORT** is equal to the **RESISTANCE**.

TRY IT OUT!

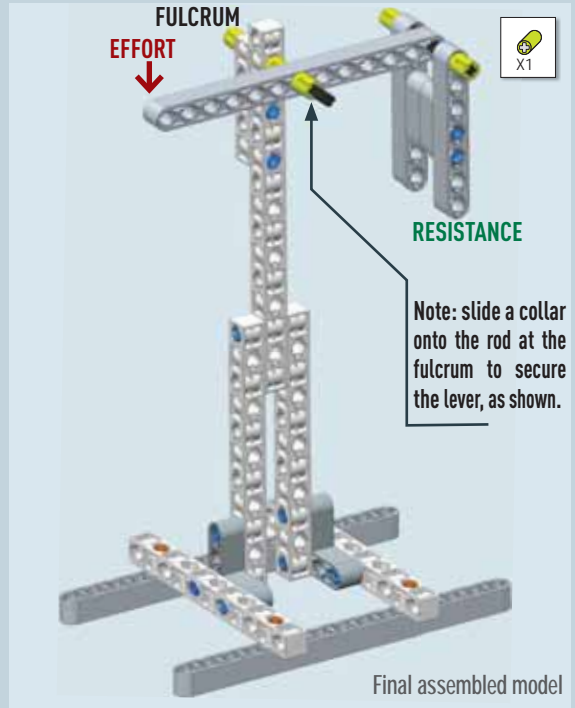

20 Assemble and test a mechanically disadvantaged lever

Find the equilibrium of this type of mechanical device: position the weight (RESISTANCE) on one side of the lever and gently press down with your hand (EFFORT) on the other side.

Note the position of the fulcrum!

- The **RESISTANCE** arm is longer.
- The **EFFORT** is greater than the **RESISTANCE**.

TRY IT OUT!

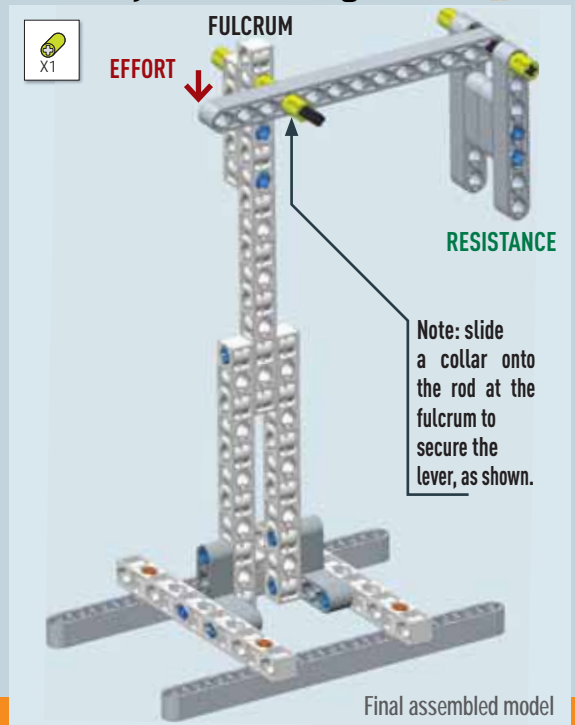

21 Assemble a set of scales

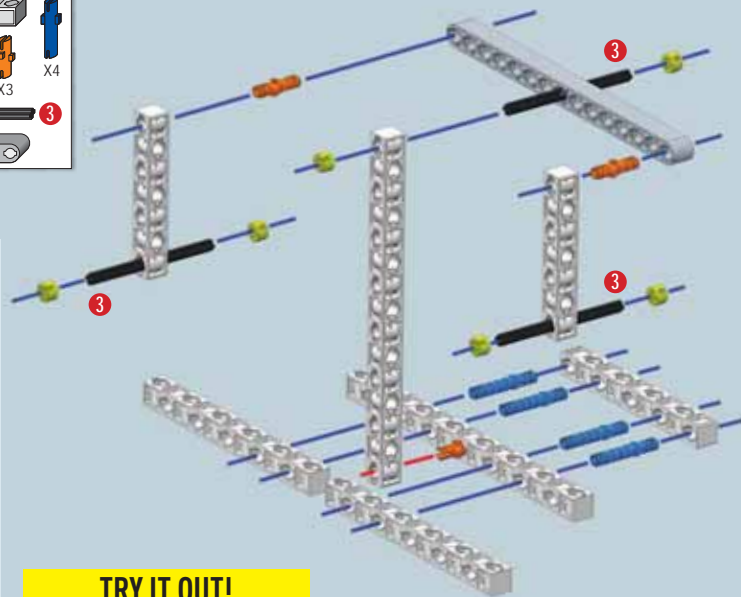
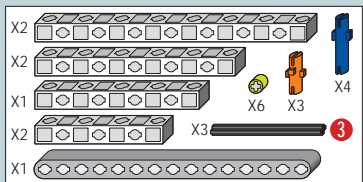

The scales are a class 1 lever

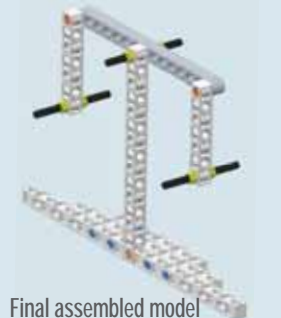

Final assembled model

TRY IT OUT!

22 Build and test a seesaw

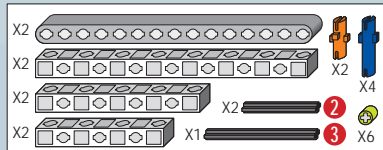

①

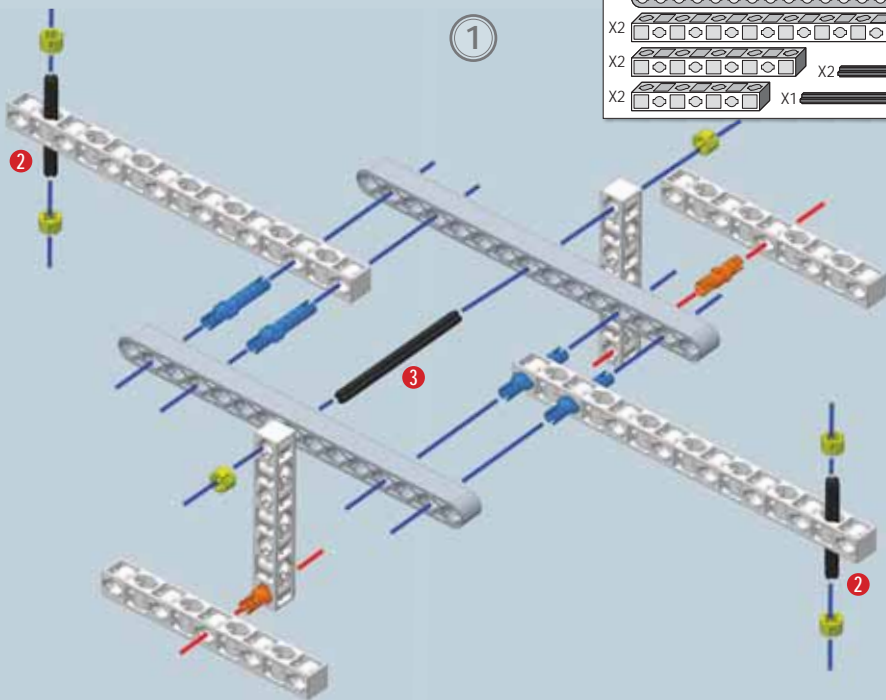

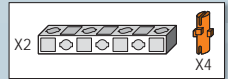

2

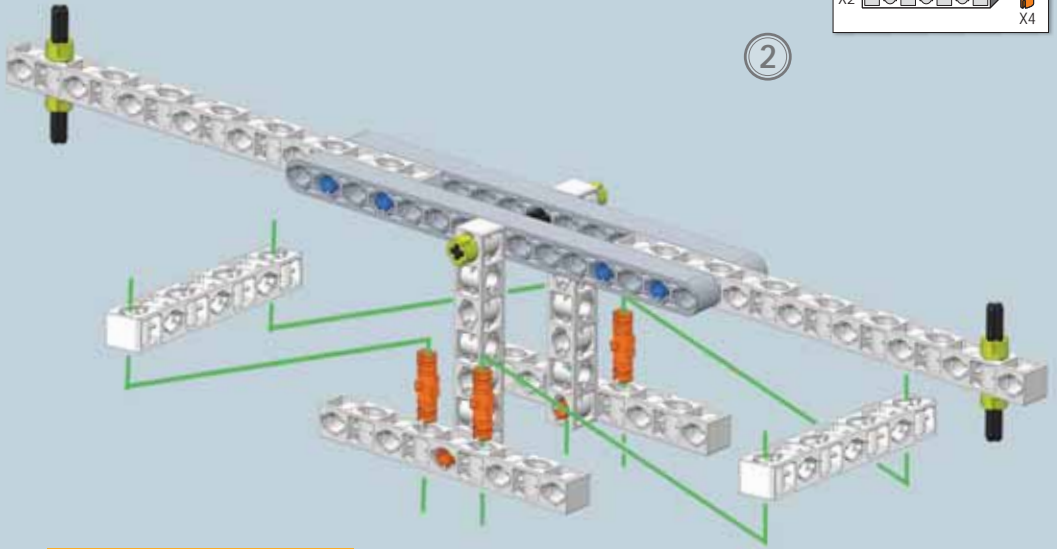

In the third century BC, Archimedes was a great scientist and experimenter with levers.

Note: the lever of the seesaw must rotate freely around the fulcrum.

Try it yourself: find the equilibrium of the seesaw by varying the weight and distances from the fulcrum of the Resistance and Effort forces.

TRY IT OUT!

The seesaw is a class 1 lever



Final assembled model

Cogwheels transmit motion between suitably positioned axles (rods) via teeth.

- In a pair of cogwheels, if one turns in one direction the other turns in the opposite direction. One of the two wheels transmits the motion (driving wheel) while the other receives it (driven wheel).
- To maintain the same direction of rotation a third cogwheel *must be inserted between the two*.
- With two different cogwheels, the smaller one, with only a few teeth, is called the **pinion**, while the other one, with lots of teeth, is called the **crown wheel**. Multiple cogwheels make up a gear train.

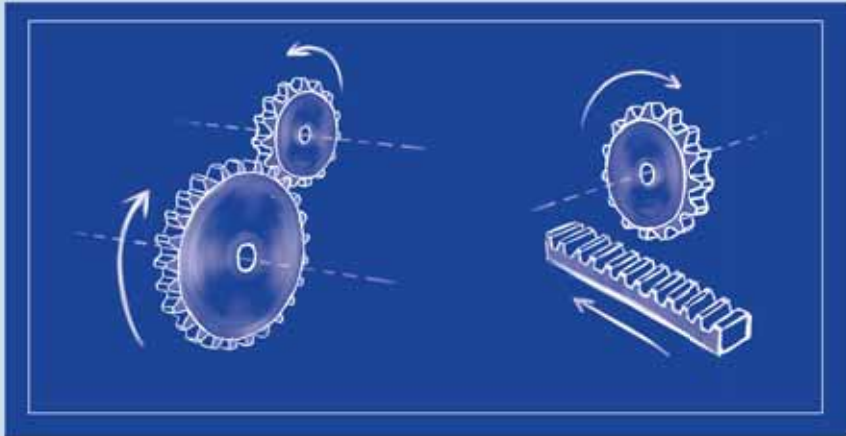

23 Assemble the test stand for reverse rotation

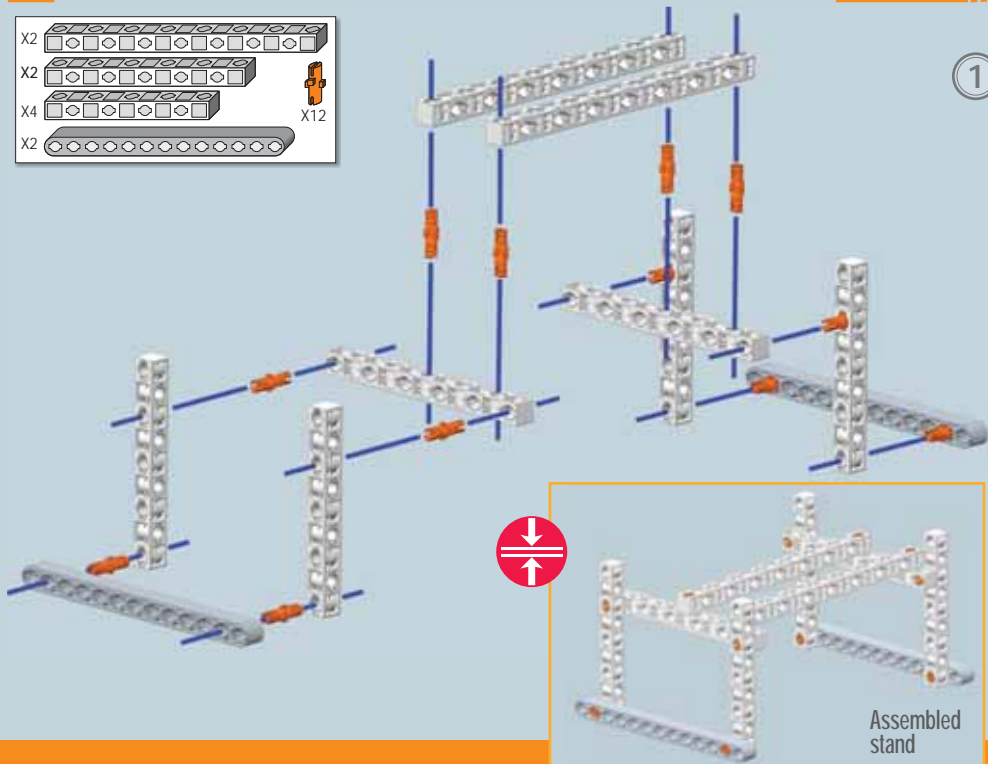
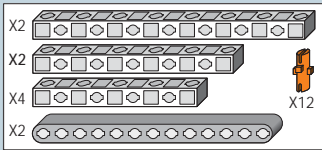

Assembled stand

2

X1		X2		X2		X1		X1	
X1		X1		X3		X1		X1	

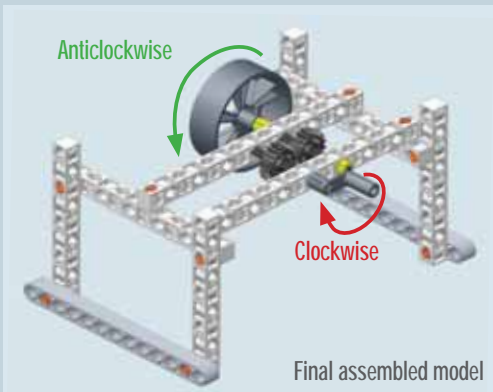
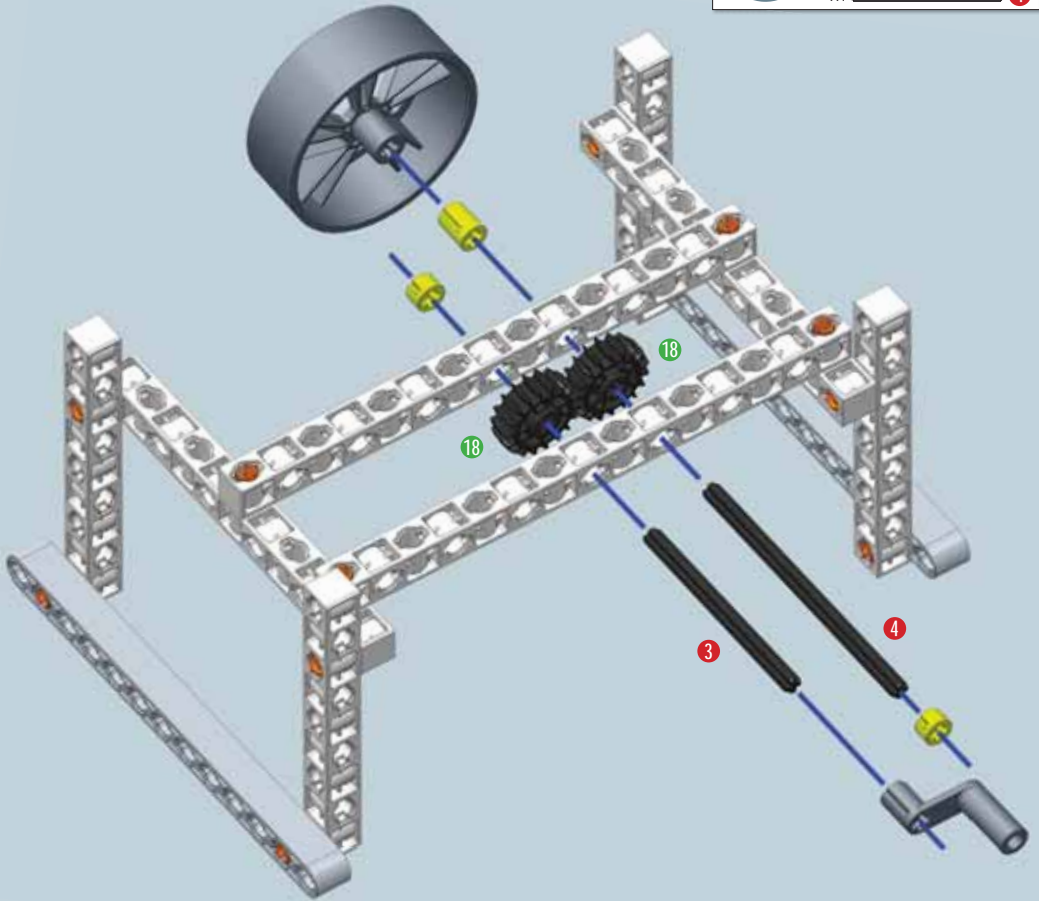

24 Build and test forward rotation

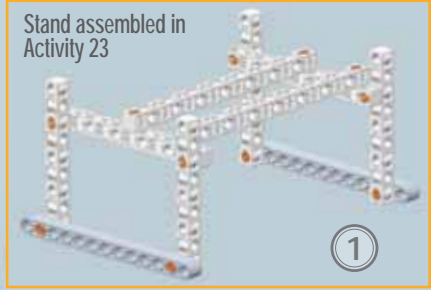
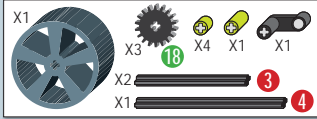

2

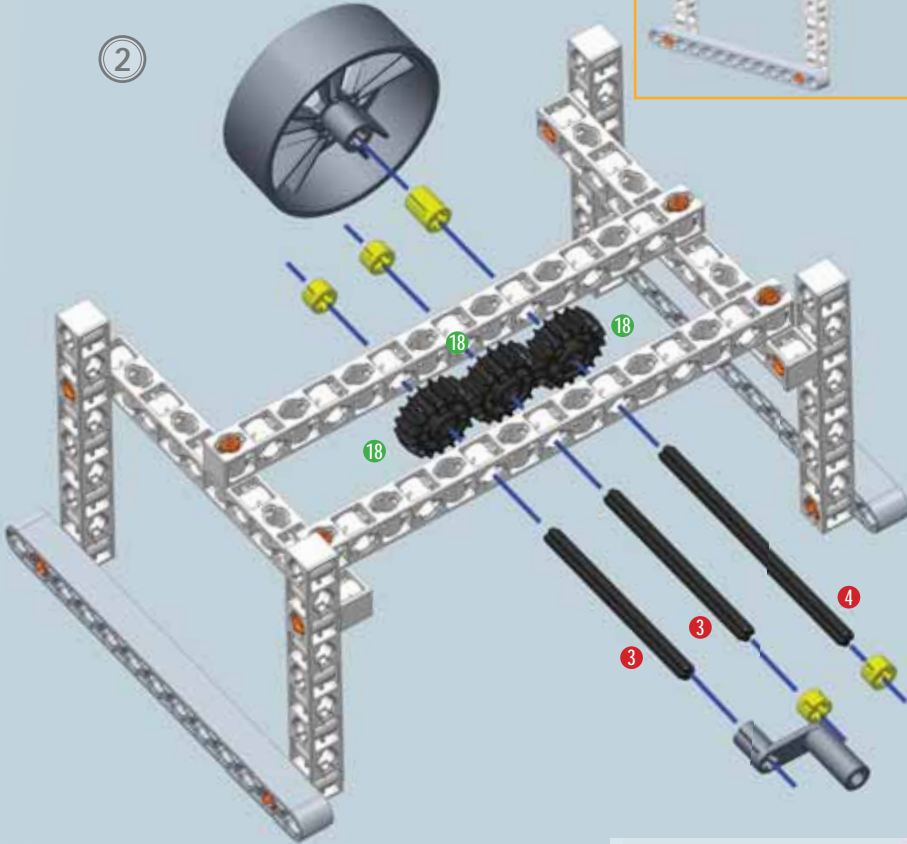

1

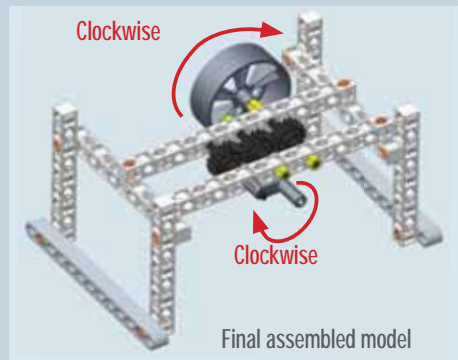

25 Assemble and test reciprocating motion

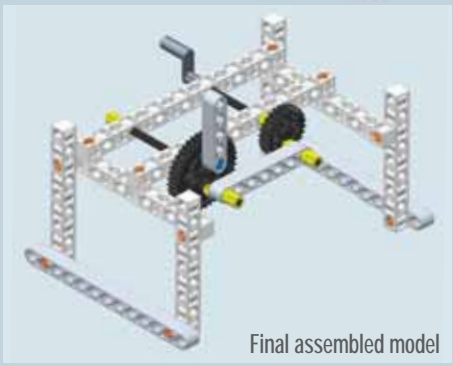
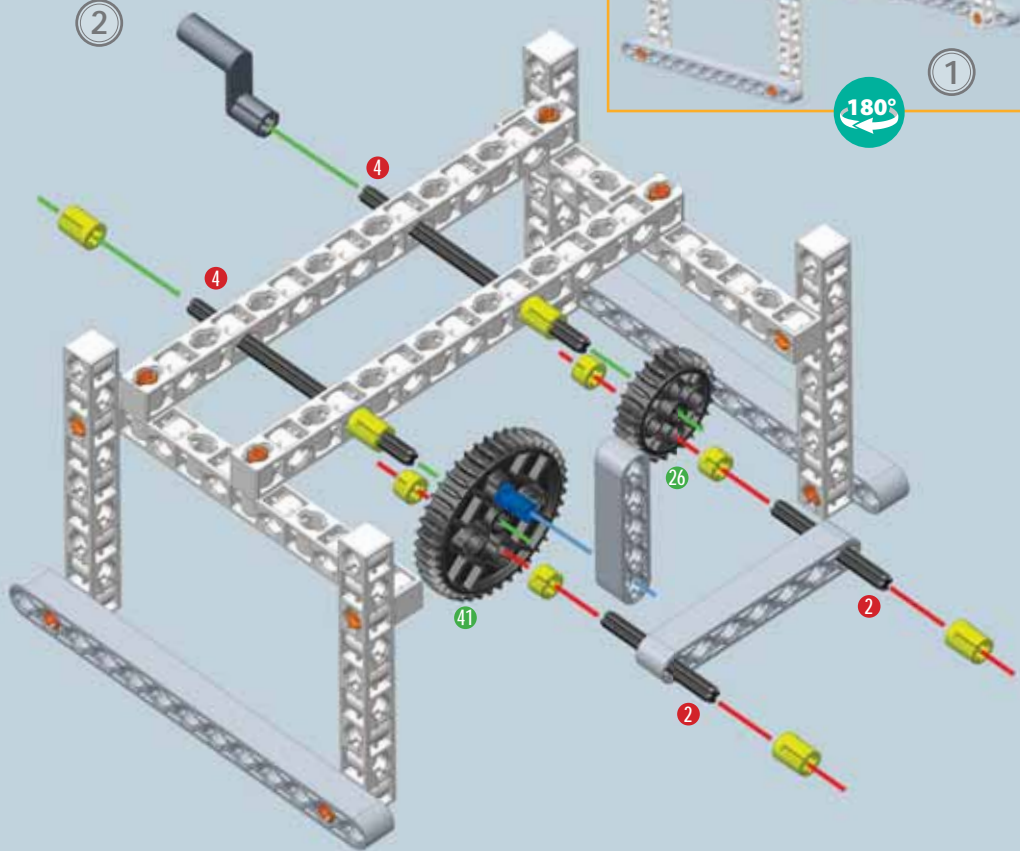
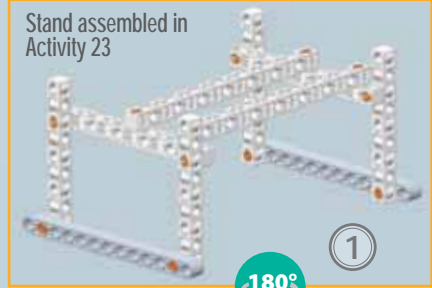
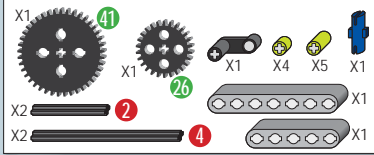

26 Build and observe right-angle rotation

Stand assembled in Activity 23

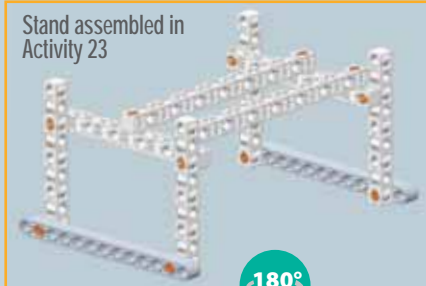

180°

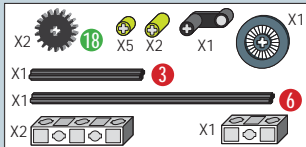
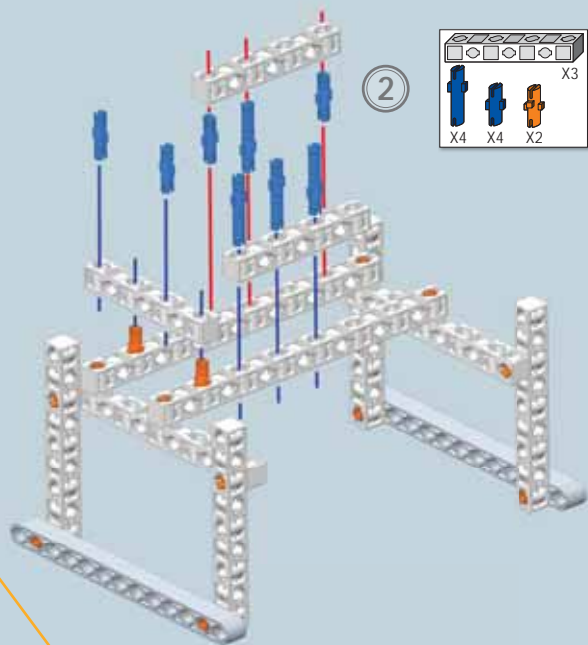

3

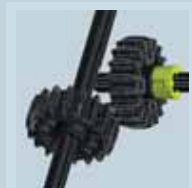
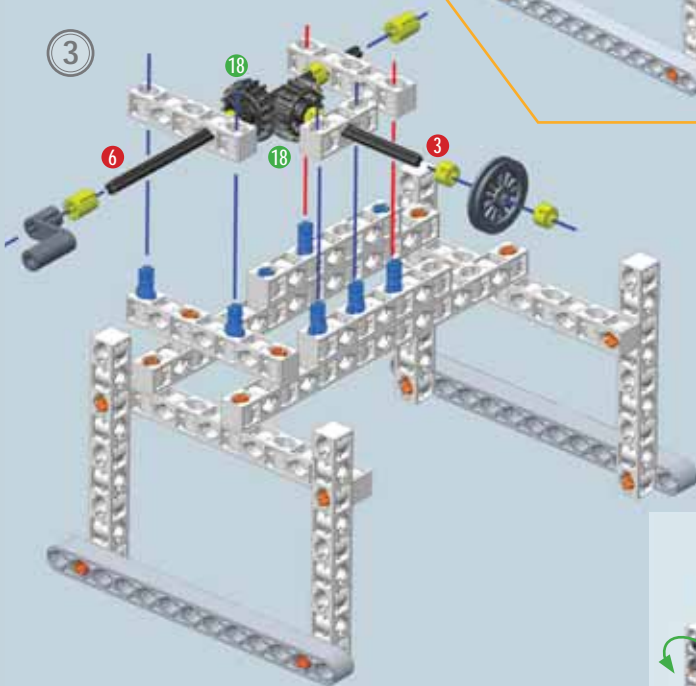

The two cogwheels must engage with each other at right angles, with the two rods almost touching.

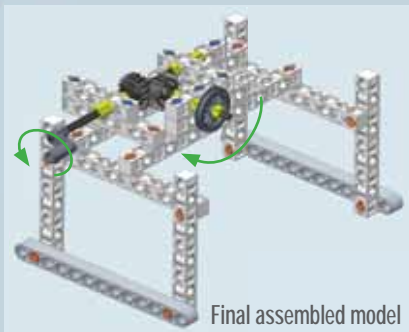

Final assembled model



27 Assemble a vertical gearbox

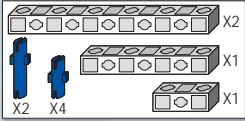

2

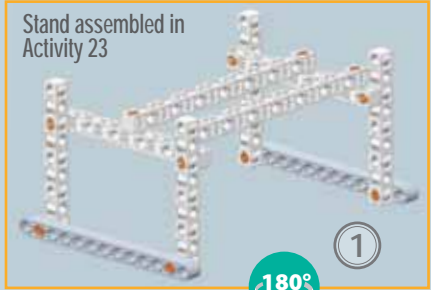
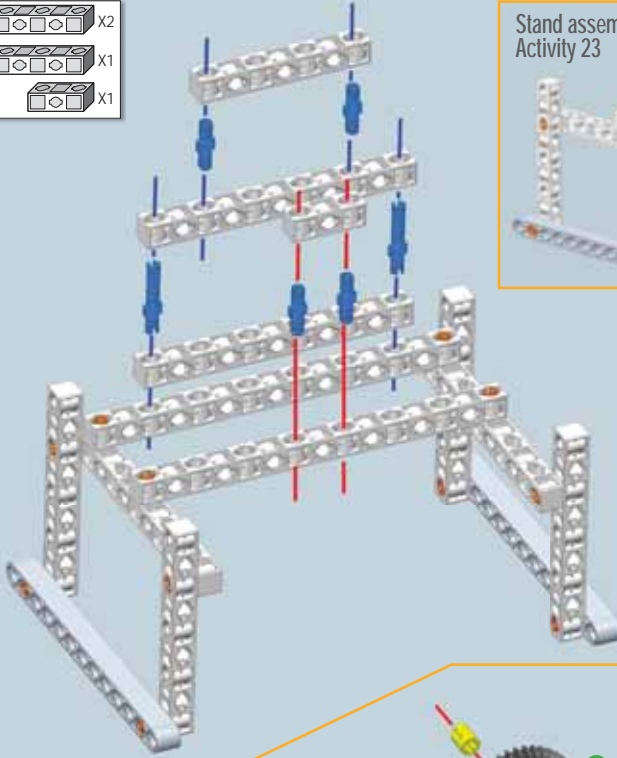

3

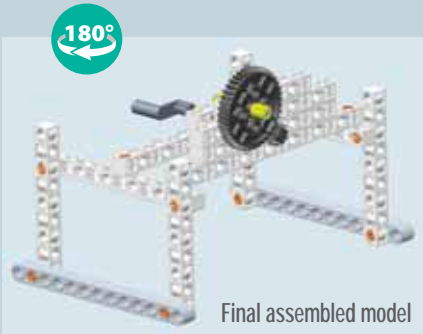
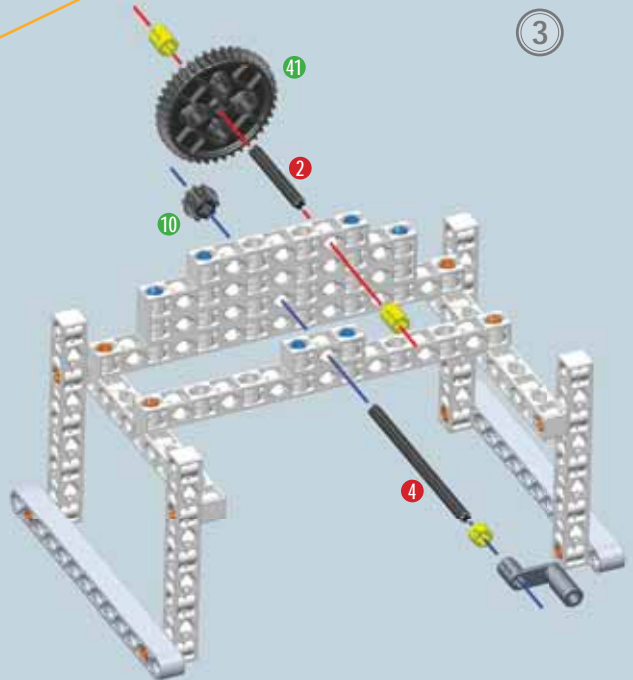

28 Build a horizontal to vertical gearbox



Stand assembled in
Activity 27



2

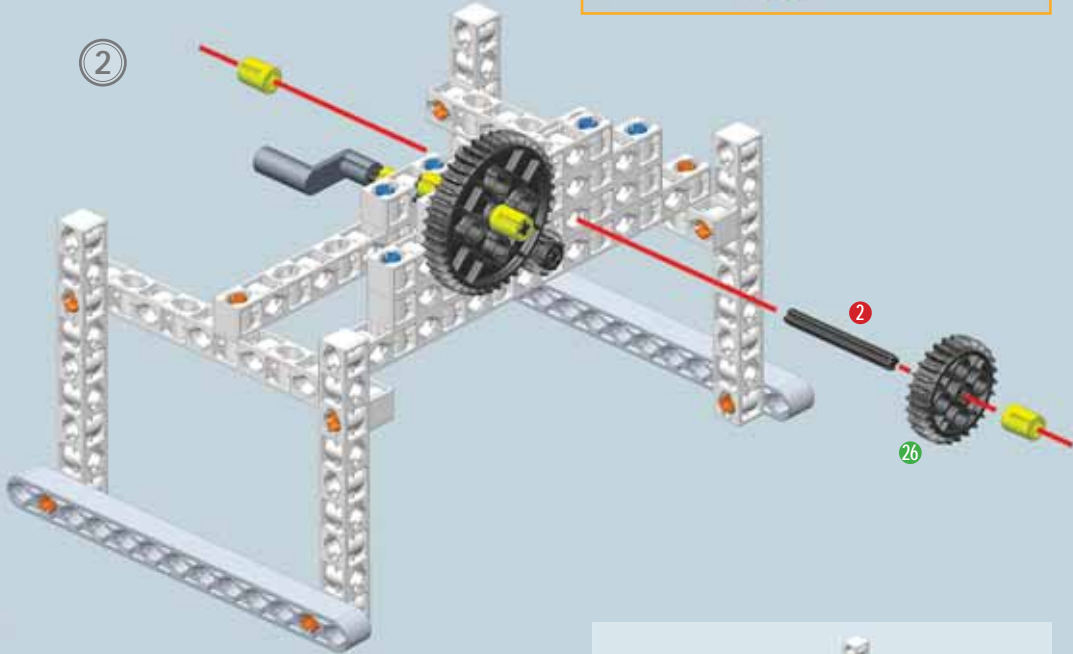

GEAR RATIO

Watch the cogwheels carefully as they turn and compare the number of rotations completed by each wheel. By the time the larger cogwheel has completed one rotation the smaller one will have completed four. You can confirm this by dividing or working out the ratio between the number of teeth on each cogwheel.

Example: how to calculate the gear ratio.

$$\frac{41 \text{ teeth (larger wheel)}}{10 \text{ teeth (smaller wheel)}} = 4.1 \text{ rotations}$$

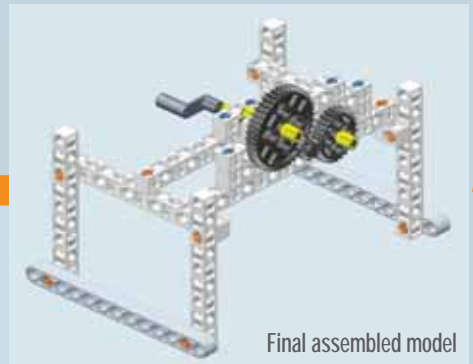

Final assembled model

1:1



29 An ancient war machine: the battering ram

1

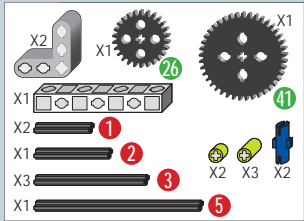
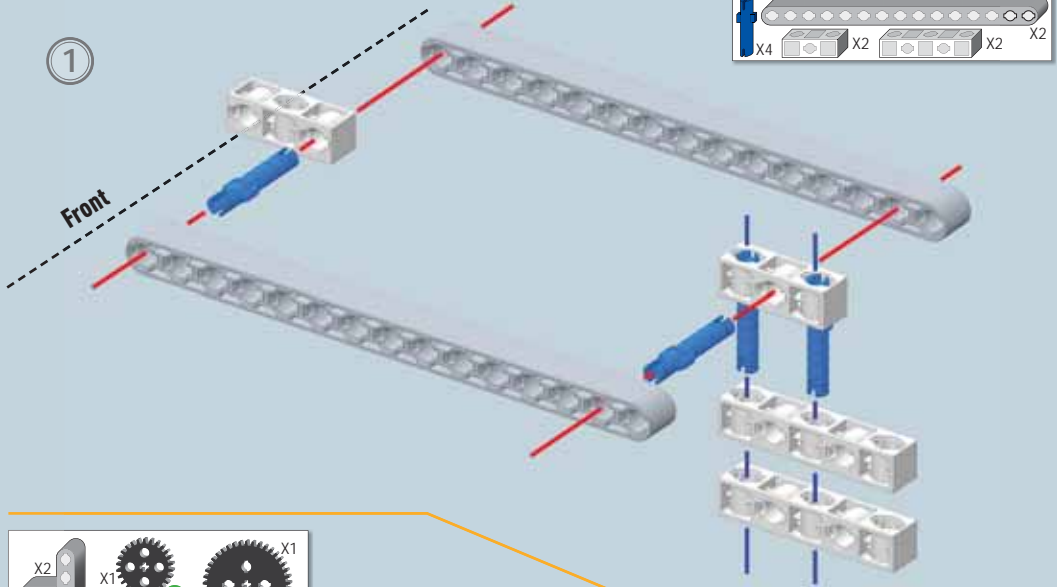

2

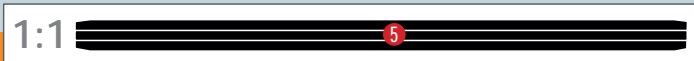
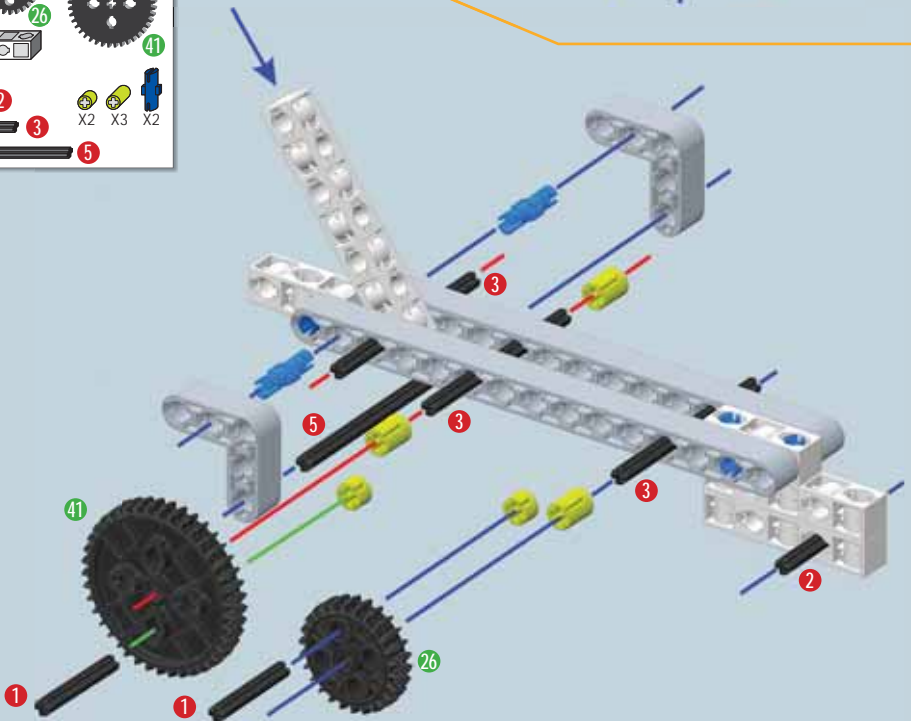

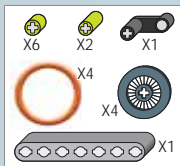

3

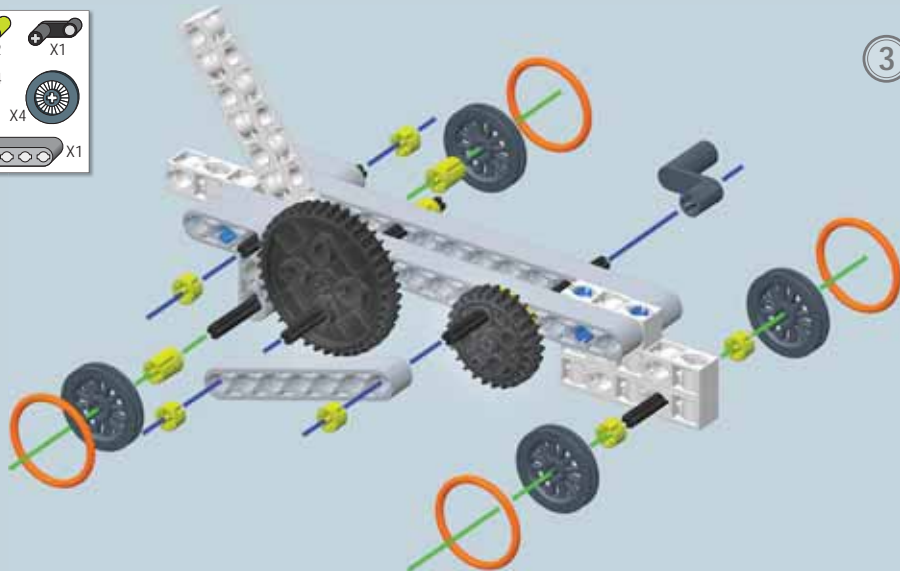

4

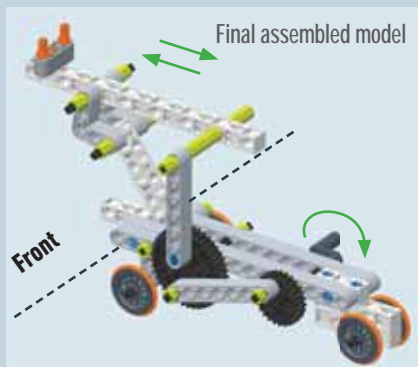
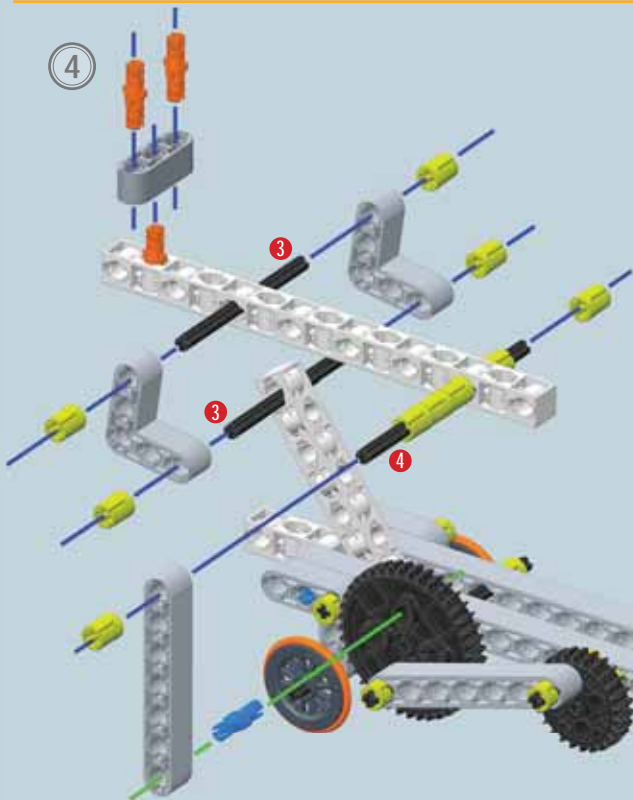
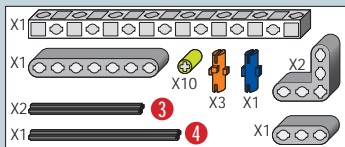

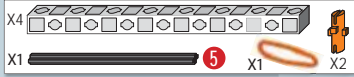

1

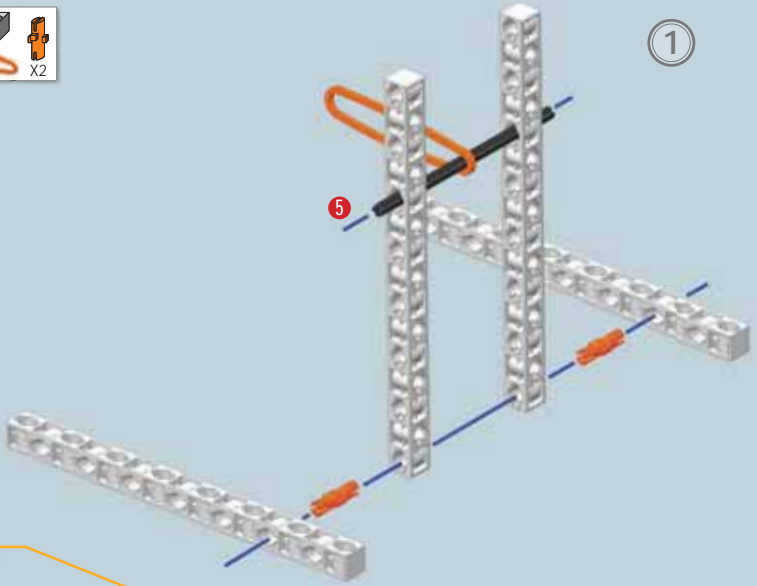

Technical facts and curiosities

Third century BC

Archimedes perfected the catapult, a war machine in use in Greece at the time of Alexander the Great.

It is a torsion machine which, in his time, drew its energy from tightening bundles of rope and hair (torsion ropes). On release, the tension in the ropes launched the bowl of the catapult forwards, hurling large rocks and stone into the air.

2

Technical and scientific information

Its design was derived from the study of physics and mathematics.

The dimensions of the elastic bands (torsion ropes) were chosen in relation to the weight of the stones and distance to the target (range).

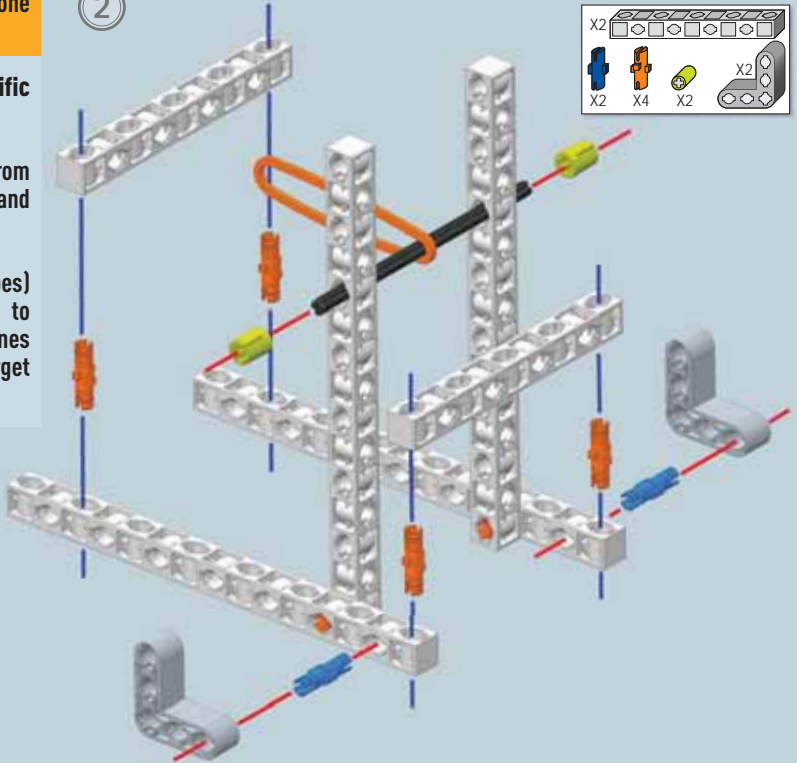

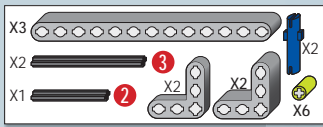

3

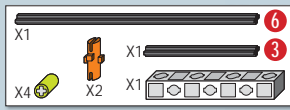
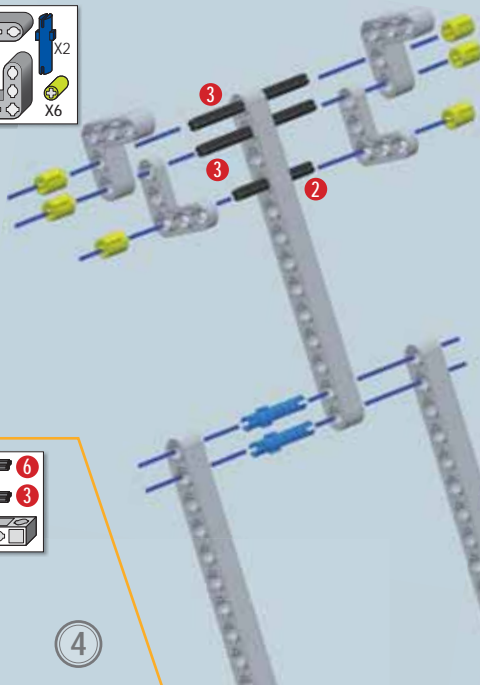

4



Final assembled model

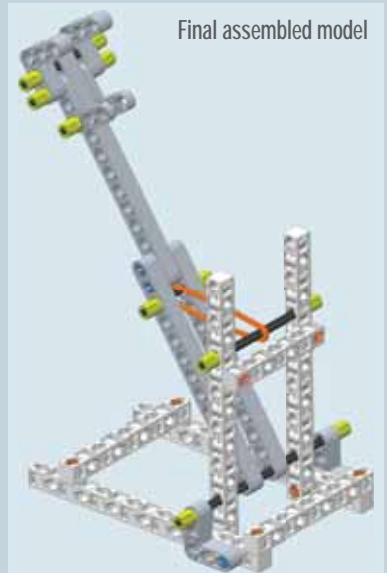

UK SUBSIDIARY: Clementoni UK Ltd
1 Olympic way – Wembley - HA9 0NP - United Kingdom
Phone: +44 208 782 1143
uk@clementoni.com

MANUFACTURER: Clementoni S.p.A.
Zona Industriale Fontenoce, s.n.c.
- 62019 Recanati (MC) - Italy
Tel. +39 071 75 811 - Fax +39 071 75 81234
www.clementoni.com

