

MERKUR[®] **017**

**MANUAL
HANDBUCH**



10 models



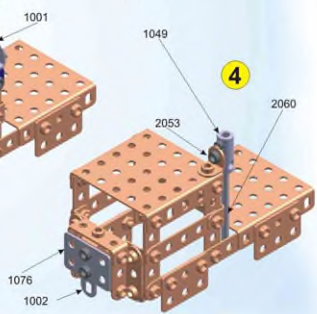
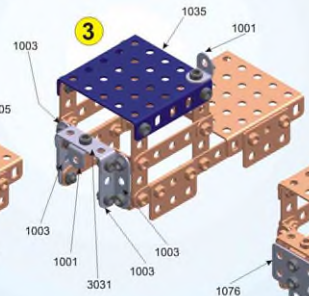
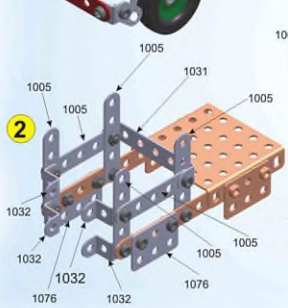
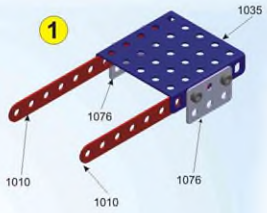
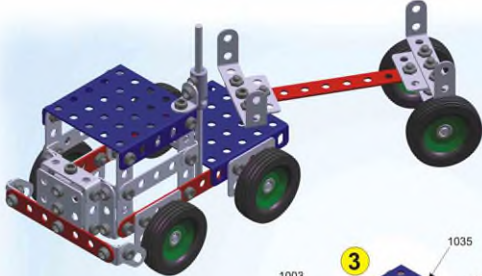

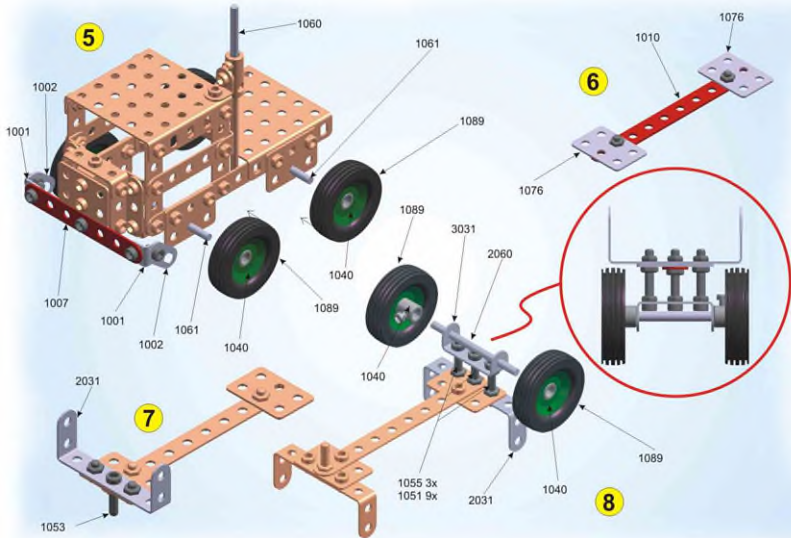

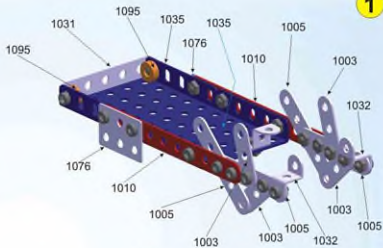
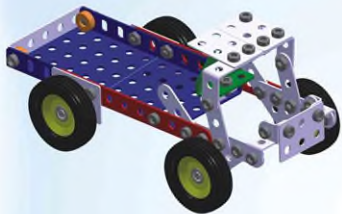

1

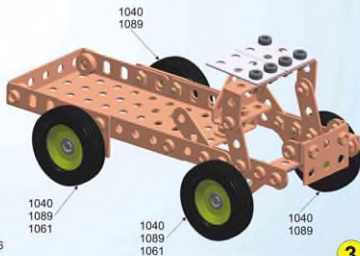
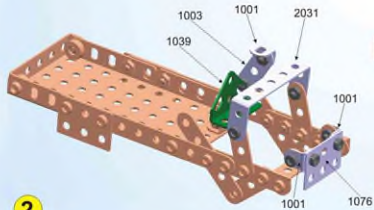

2

3

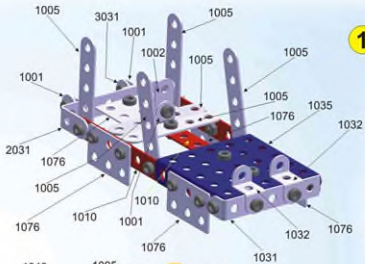
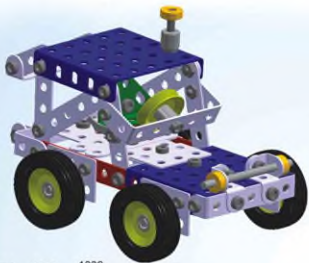

1

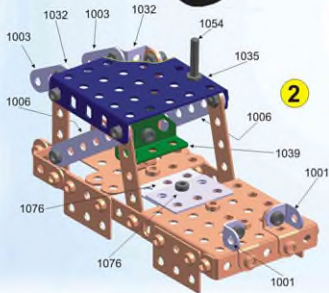

2

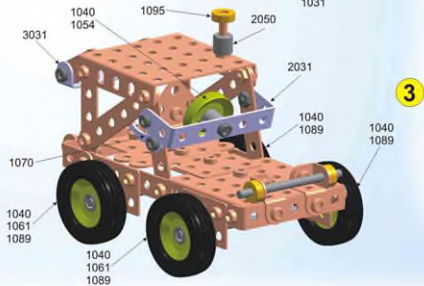

3

