

- |                  |                |                |                 |
|------------------|----------------|----------------|-----------------|
| (6mm) 1501 X 265 | (OC) D006 X 6  | (YC) D004C X 1 | (YC) D112 X 1   |
| (6mm) 1502 X 1   | (OC) D007 X 4  | (OC) 1151 X 4  | (OC) D111 X 4   |
| (12mm) 1505 X 29 | (YC) D007 X 15 | (OC) 1152 X 14 | (YC) D111 X 2   |
| (18mm) 1506 X 18 | (OC) 1251 X 44 | (OC) D802 X 6  | (YC) 1051 X 6   |
| (20mm) 1507 X 4  | (OC) 1251 X 8  | (OC) 1116 X 2  | (OC) D200 X 40  |
| (30mm) 1371 X 1  | (OC) 1252 X 2  | (YC) 1116 X 1  | (OC) D200 X 8   |
| (40mm) 1372 X 1  | (OC) 1253 X 4  | (YC) D100 X 2  | (OC) D702 X 1   |
| (50mm) 1373 X 1  | (YC) D205 X 4  | (YC) D101 X 1  | (6mm) 1401 X 8  |
| 1511 X 361       | (OC) D205 X 5  | (OC) D126 X 2  | 3037 X 1        |
| (OC) D001 X 11   | (OC) D201 X 2  | (YC) D126 X 9  | 1619 X 2        |
| (YC) D002 X 9    | (OC) D221 X 3  | (YC) D102 X 3  | 112 X 2         |
| (OC) D002 X 4    | (OC) D261 X 4  | (OC) D103 X 2  | (6mm) 1394 X 1  |
| (OC) D003 X 25   | (YC) D005 X 22 | (OC) D114 X 1  | 3034 X 1        |
| (YC) D004 X 2    | (OC) D006 X 6  | (YC) D103 X 2  | (16mm) 3035 X 2 |
| (OC) D005 X 4    | (YC) D261 X 4  | (OC) D103 X 2  | (16mm) 3036 X 1 |
| (YC) D005 X 22   | (OC) D006 X 6  | (OC) D103 X 2  |                 |
| (YC) D006 X 6    |                |                |                 |

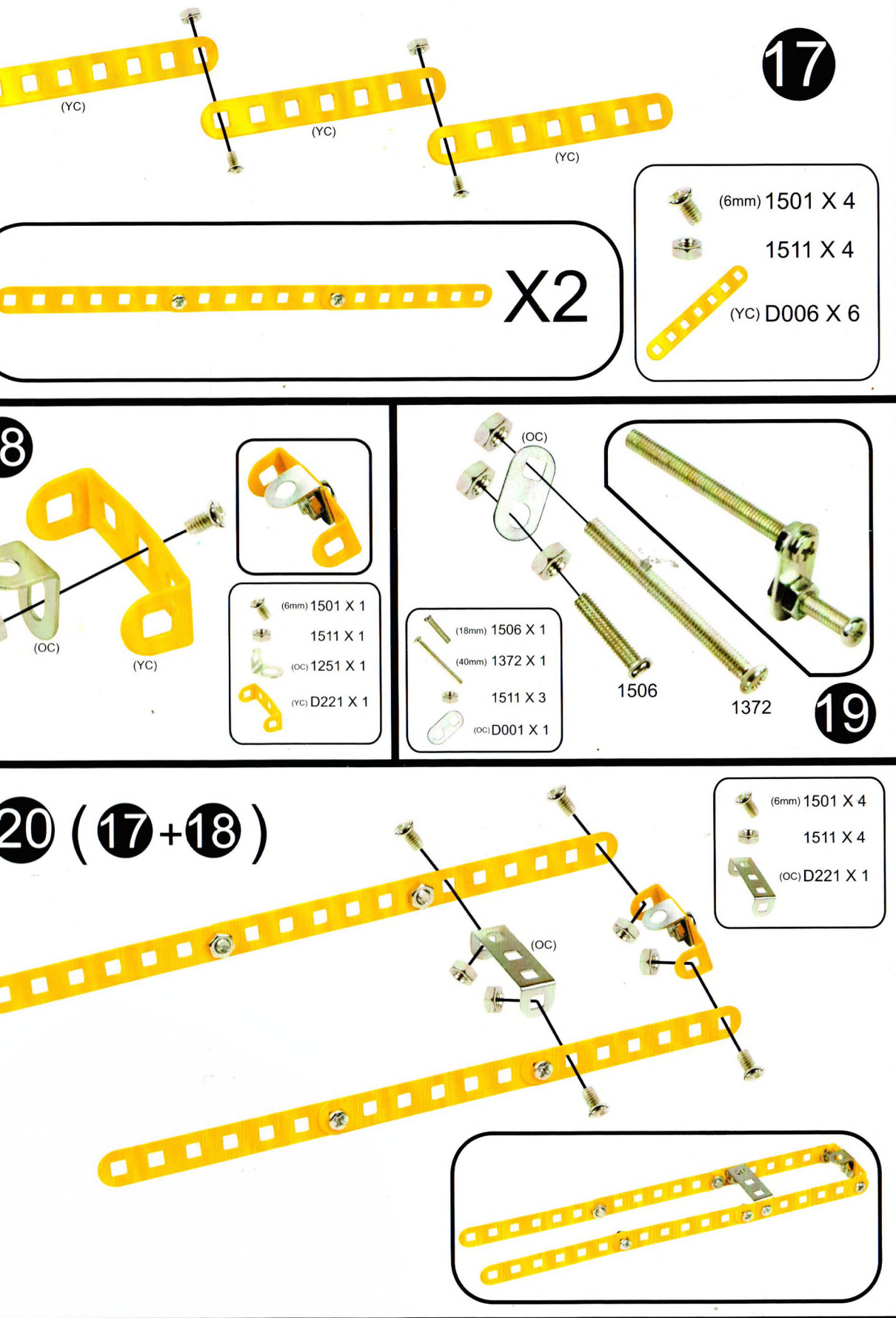

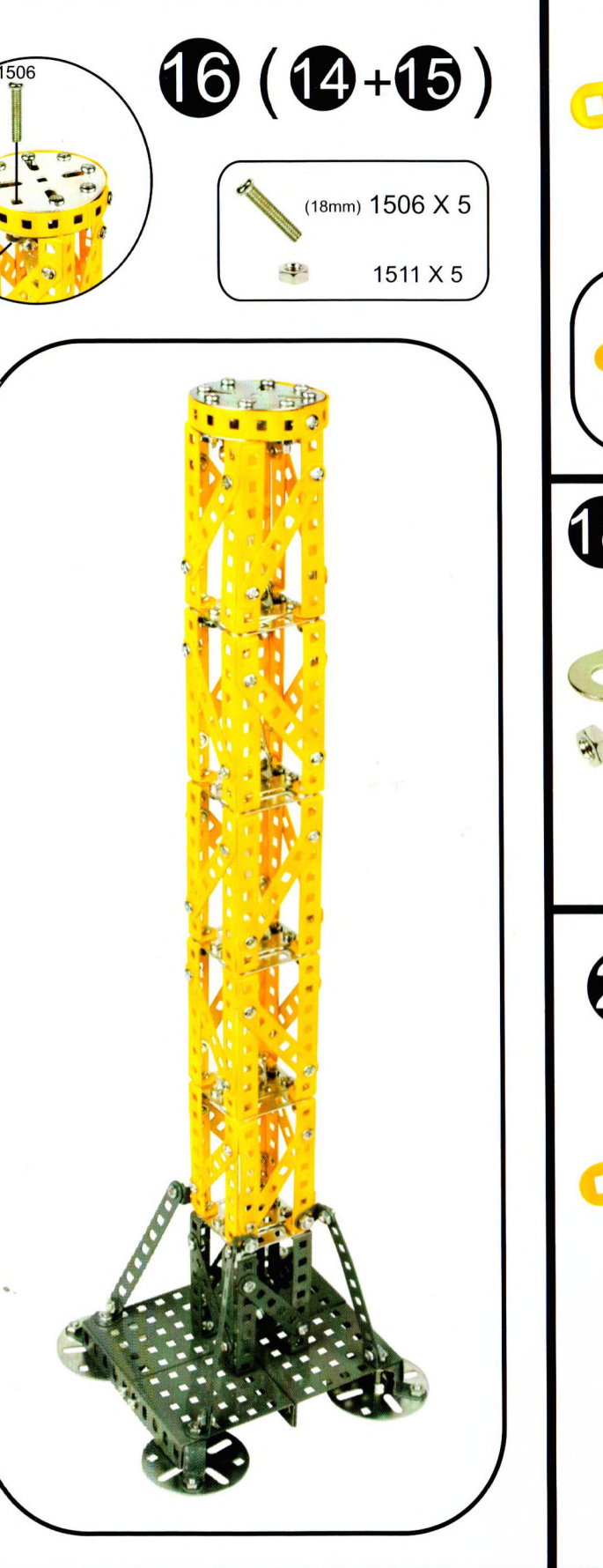
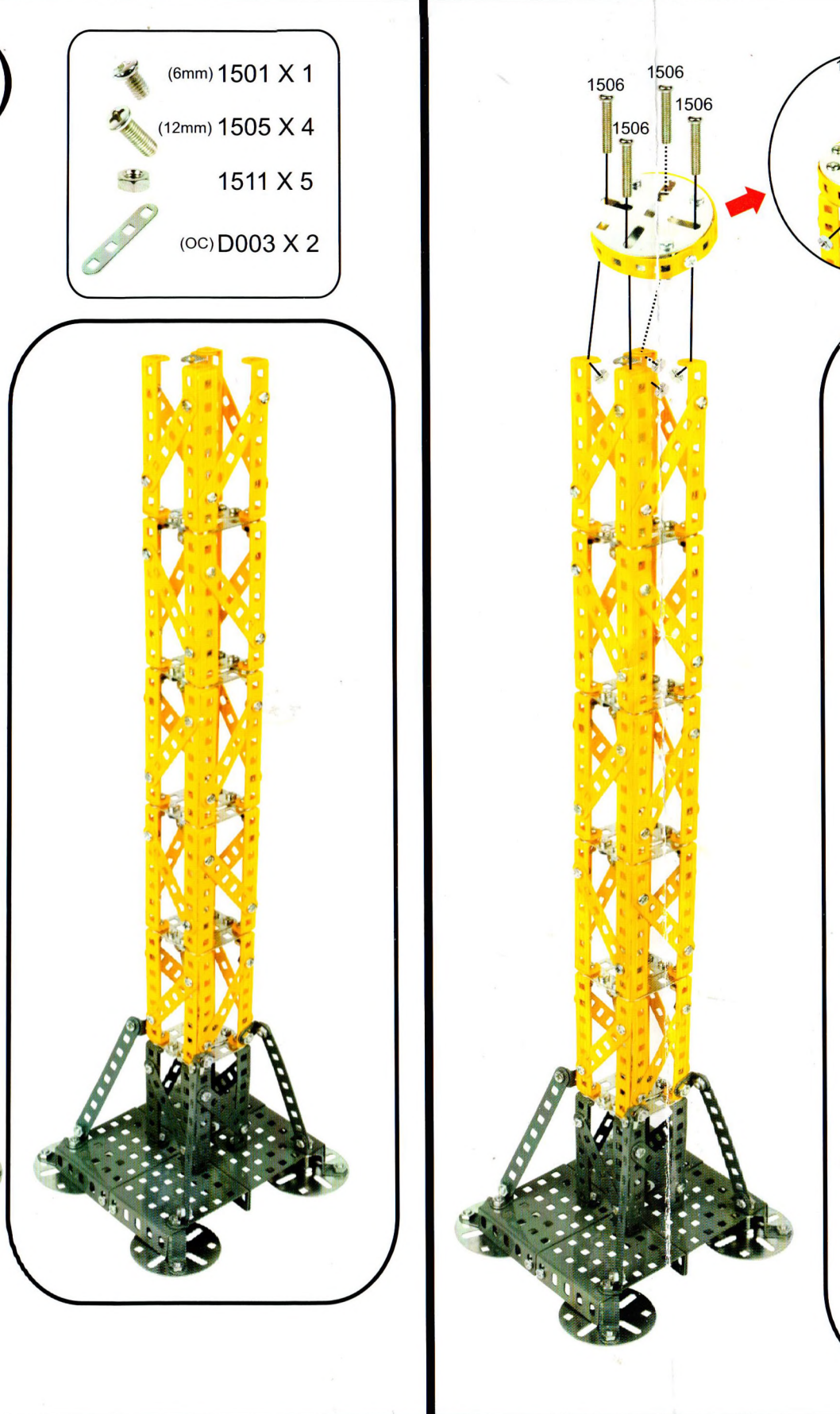
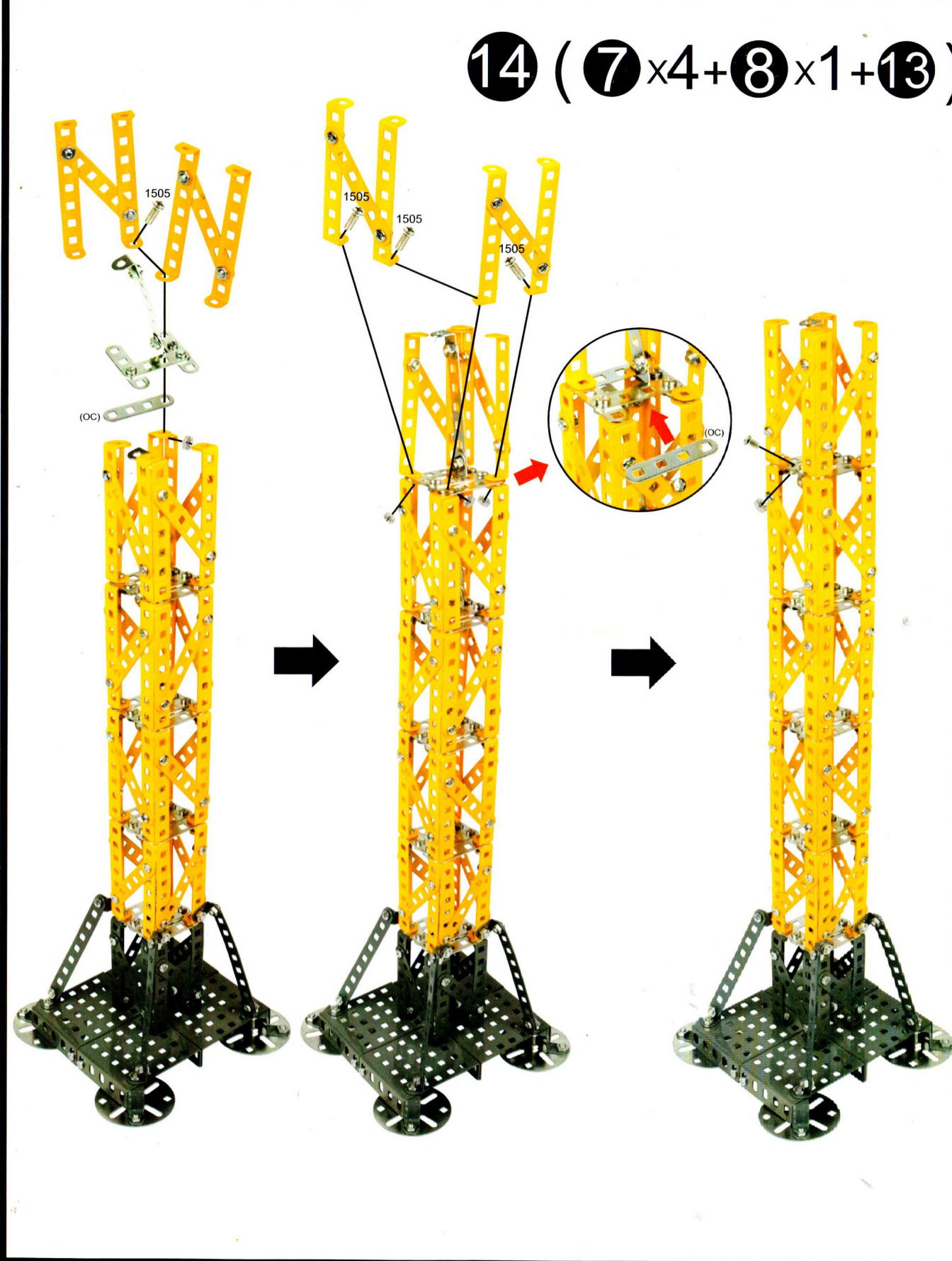
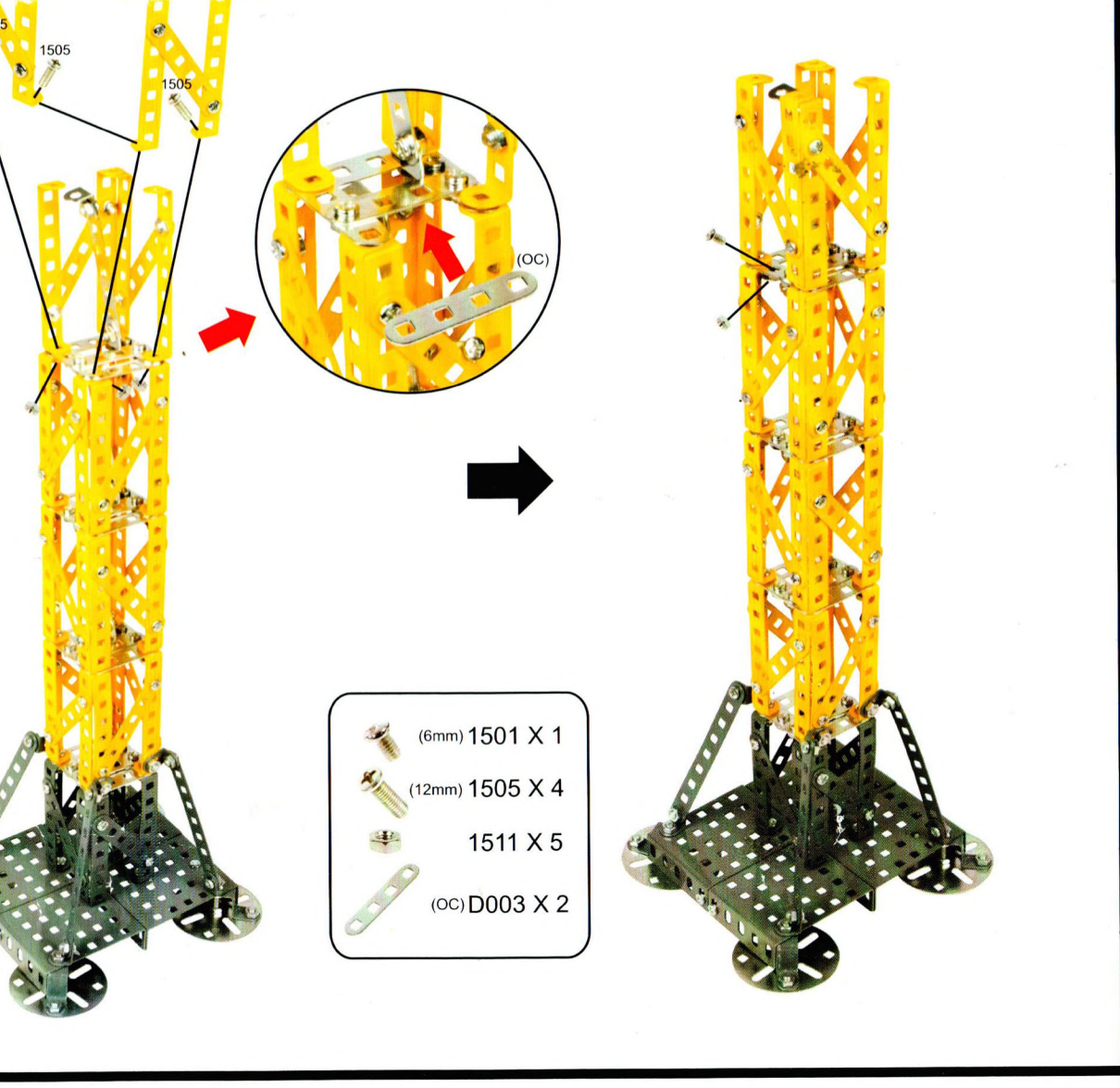
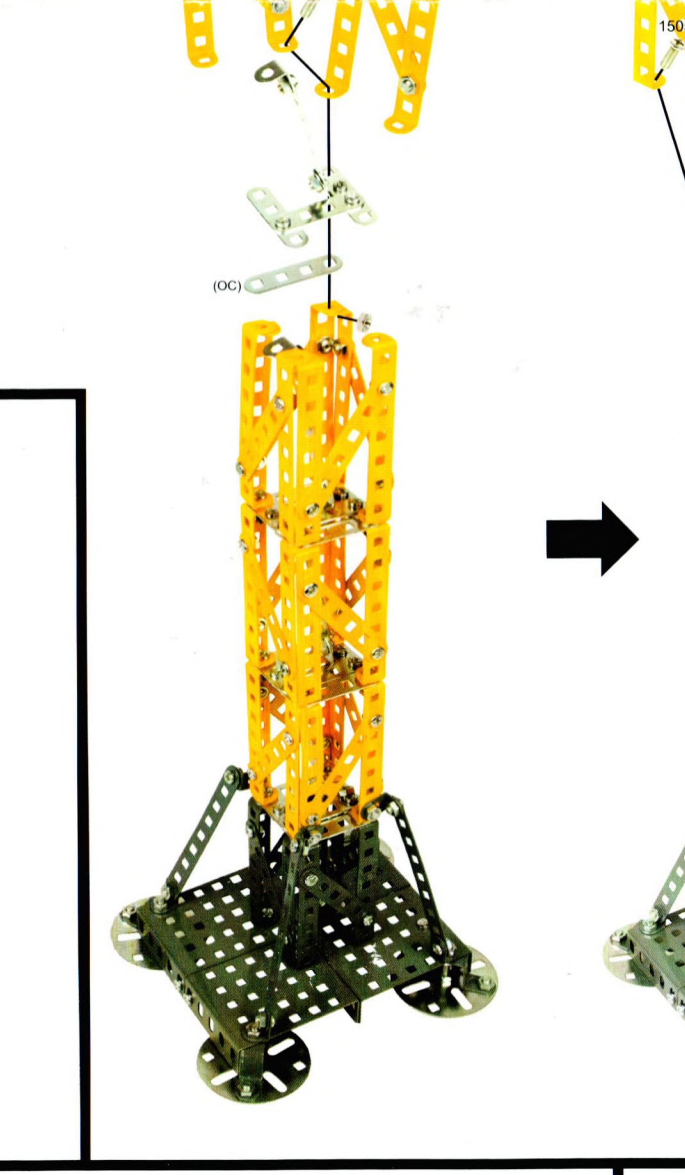
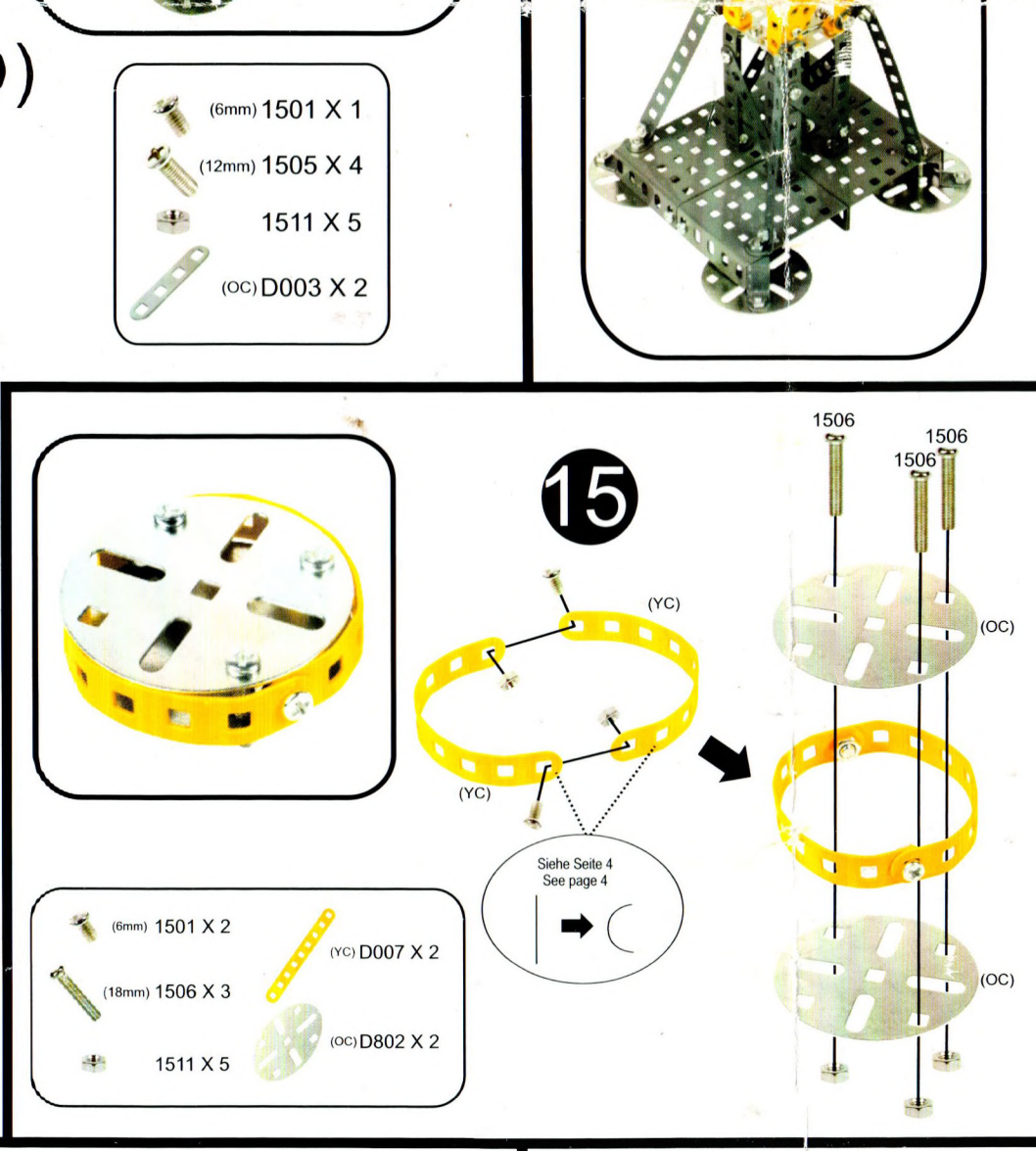
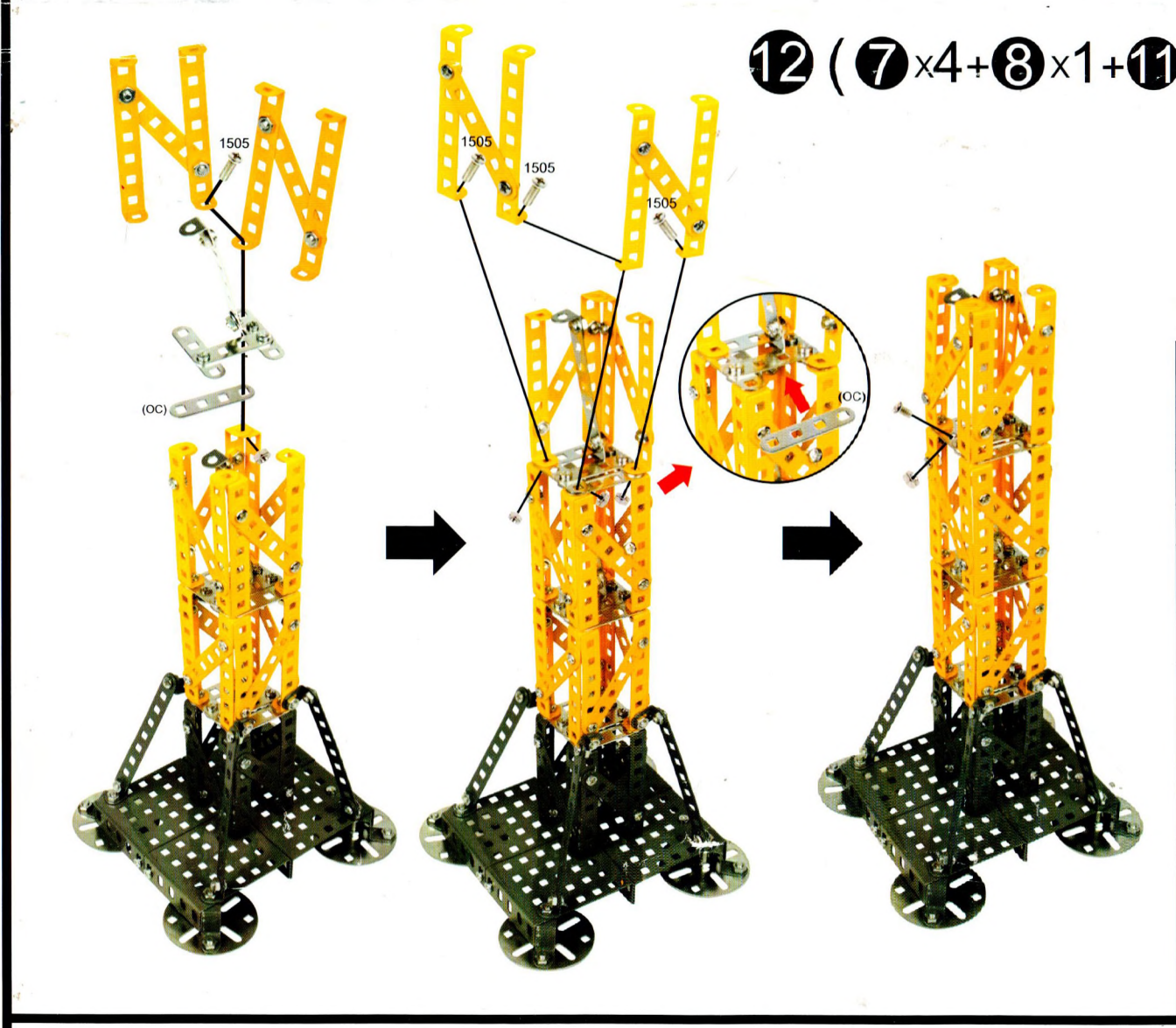
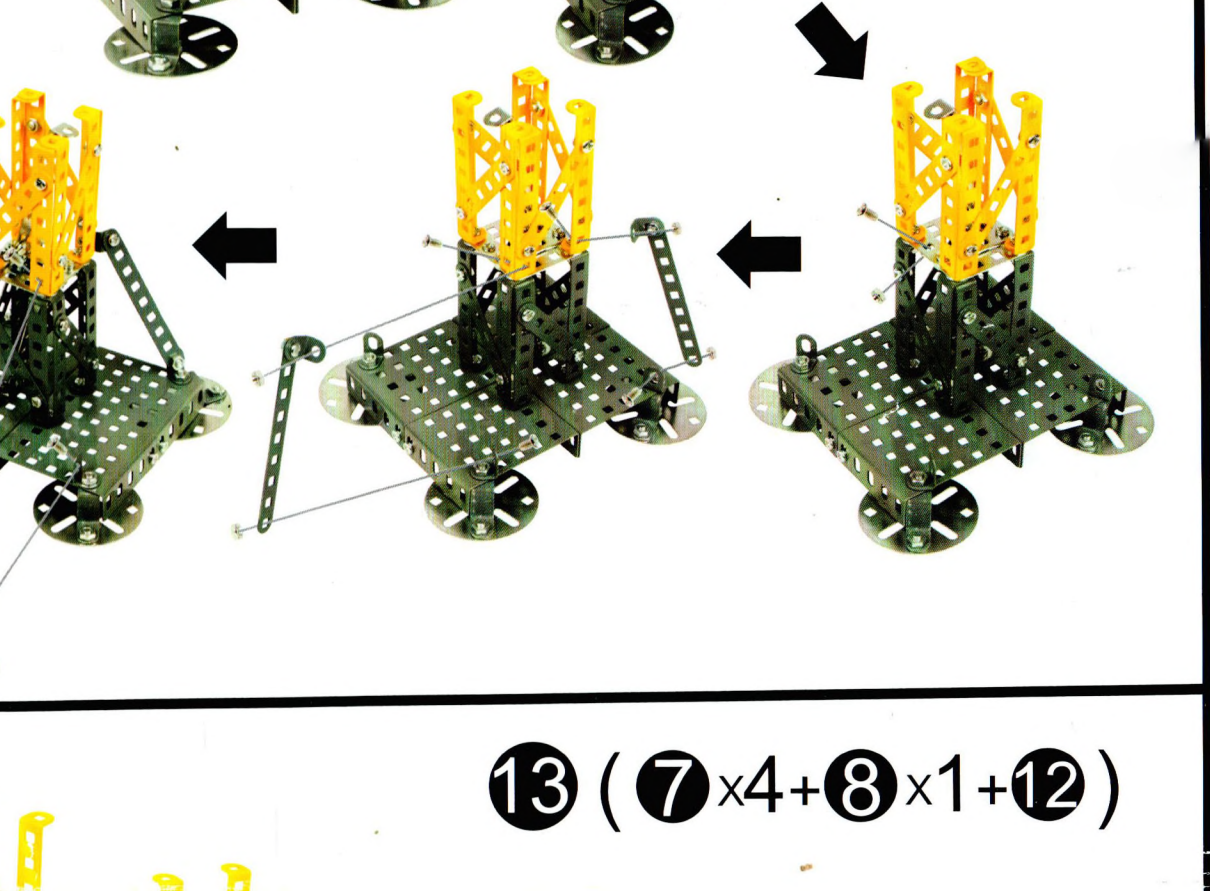
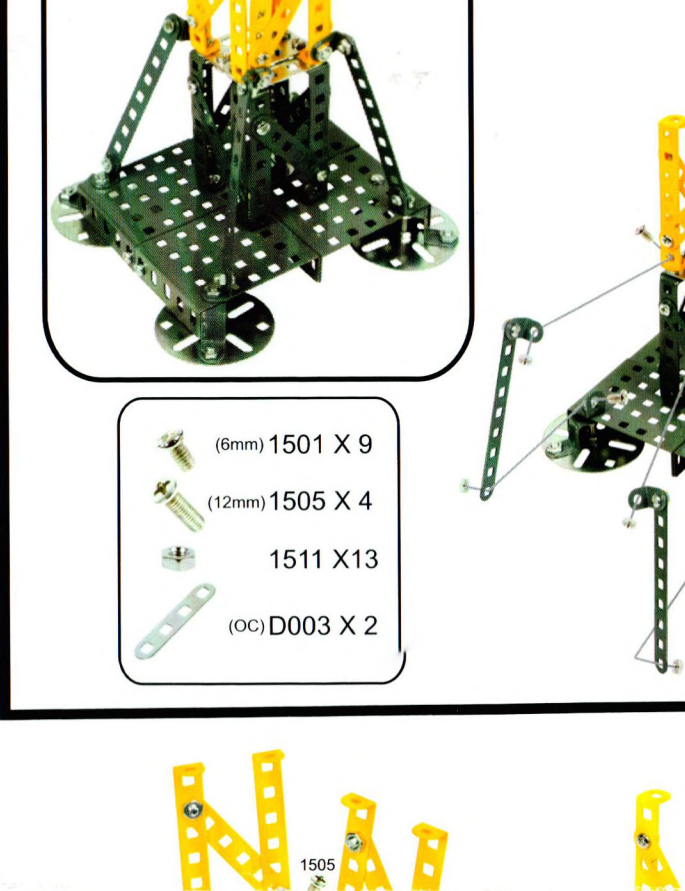
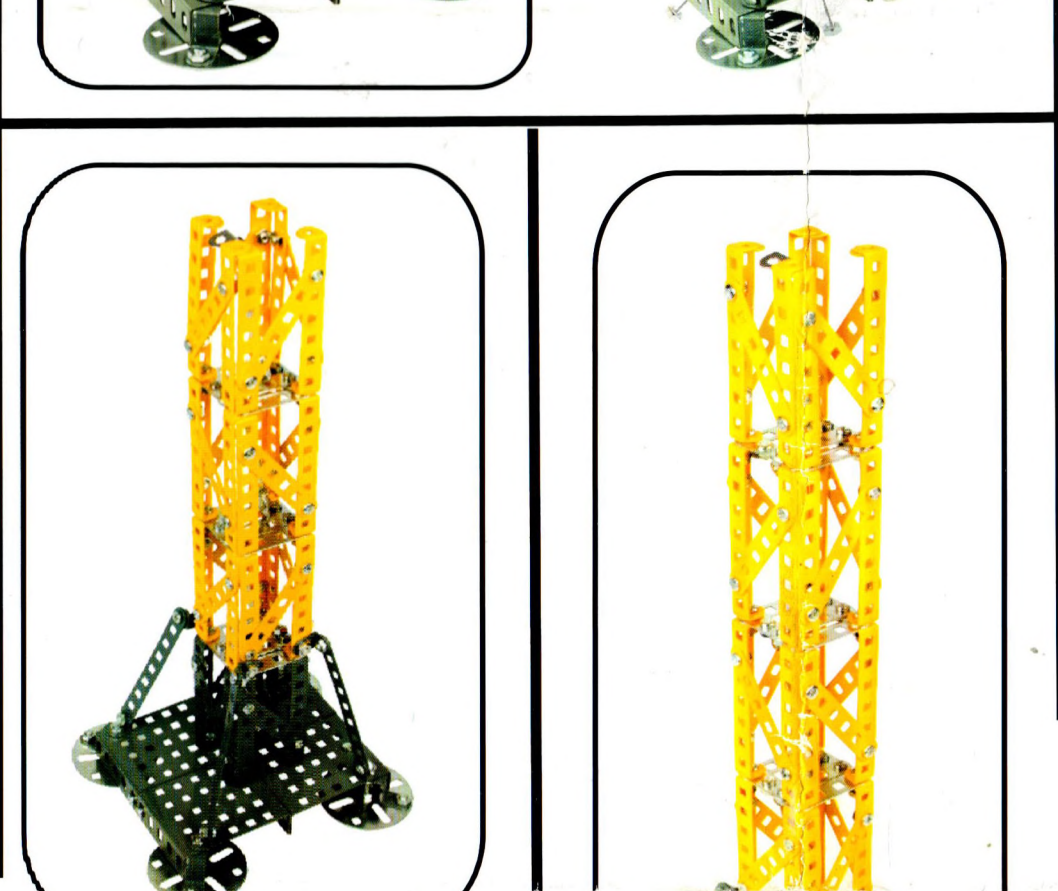
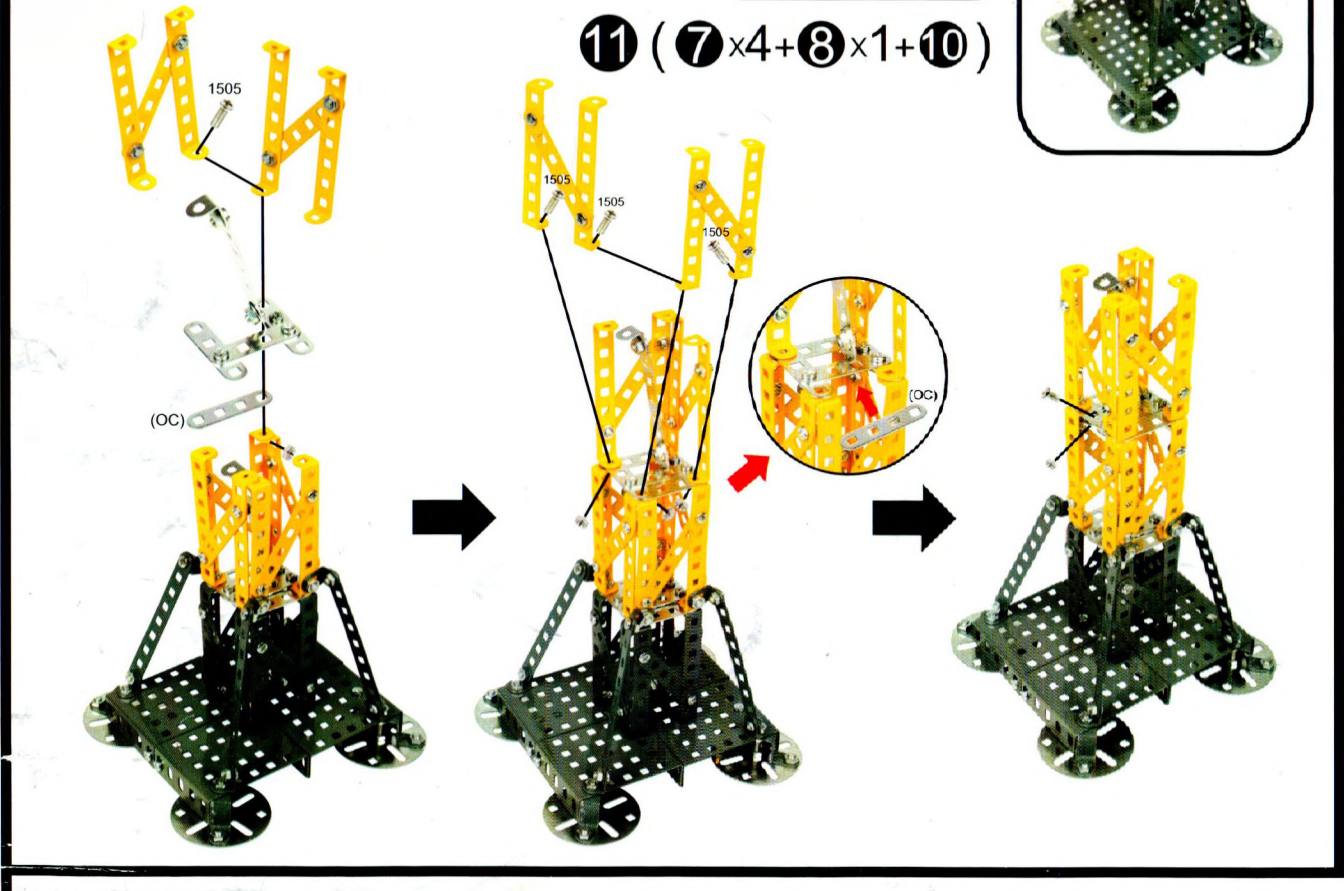
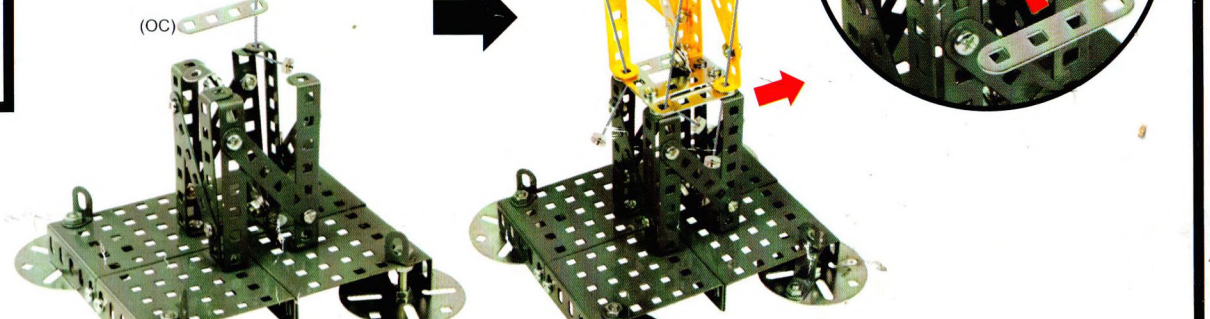
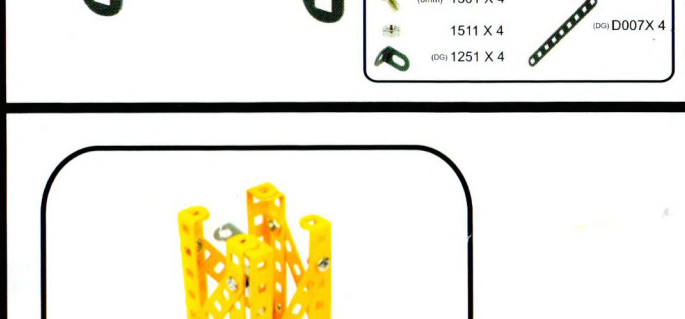
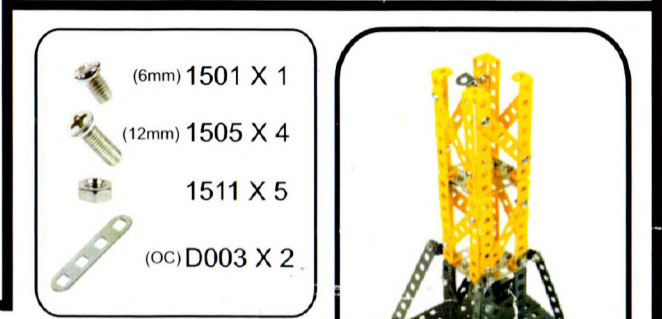
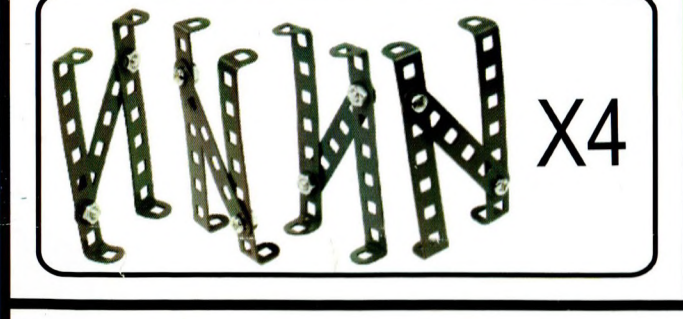
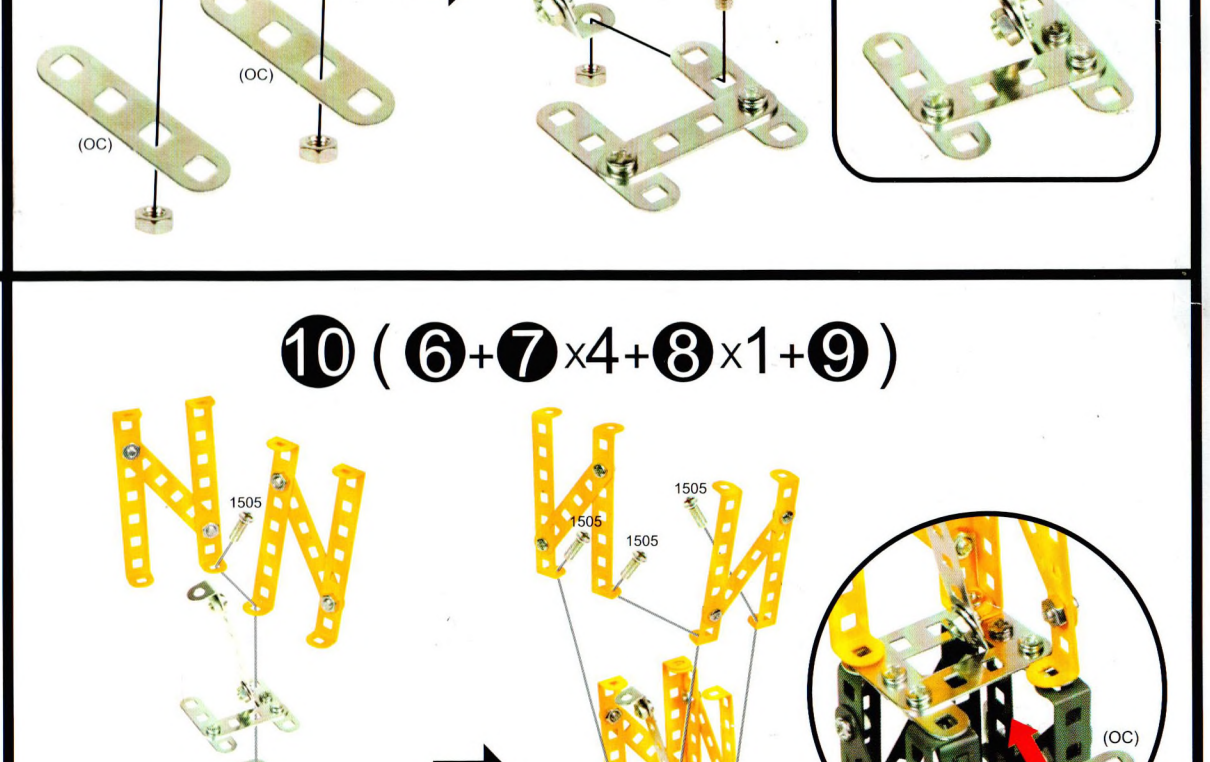
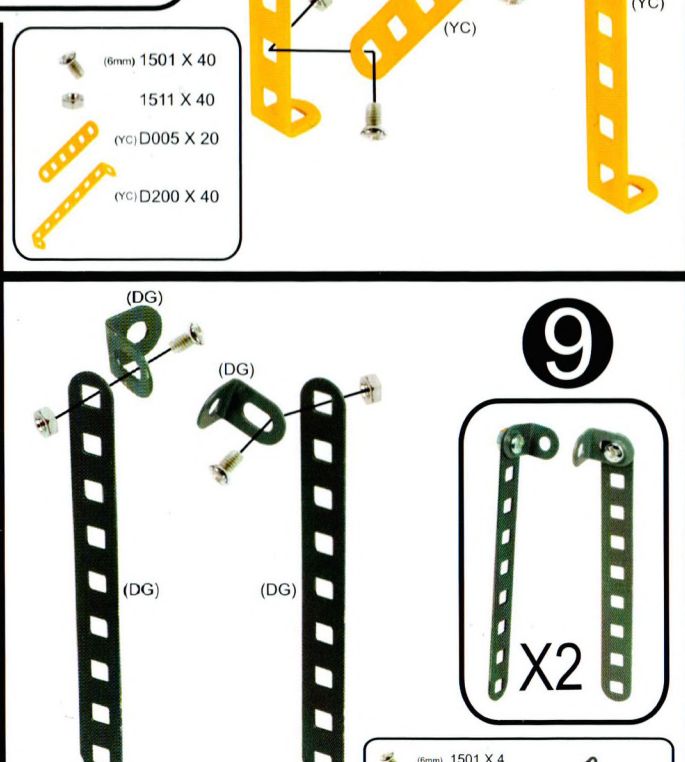
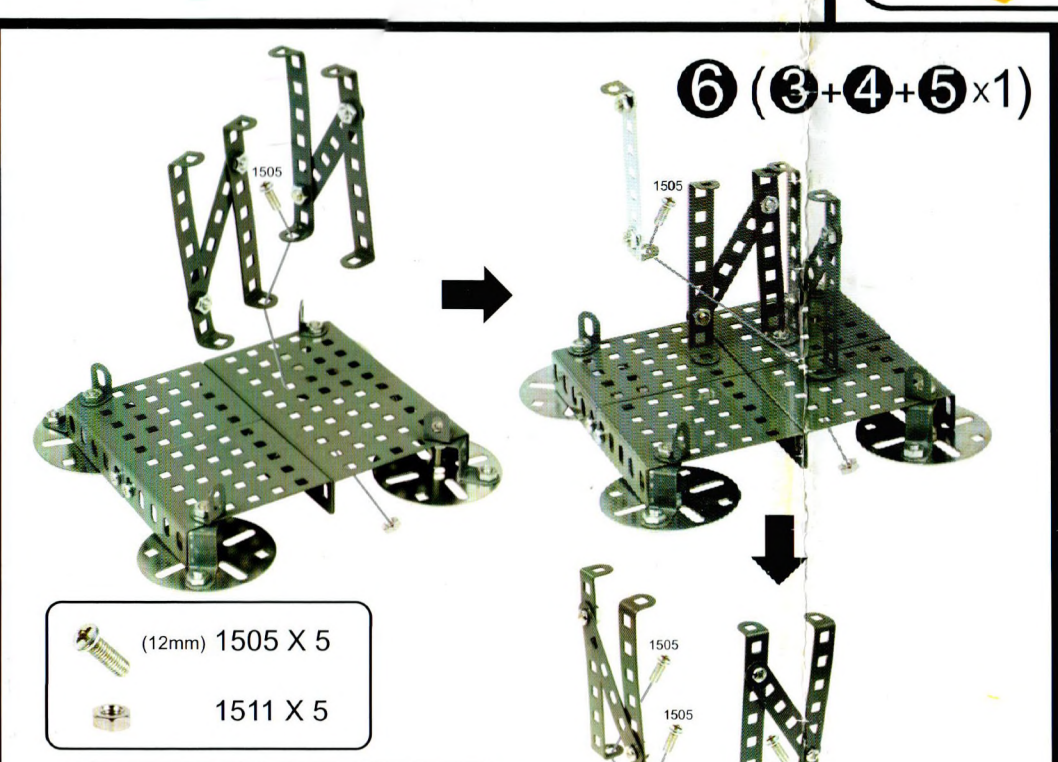
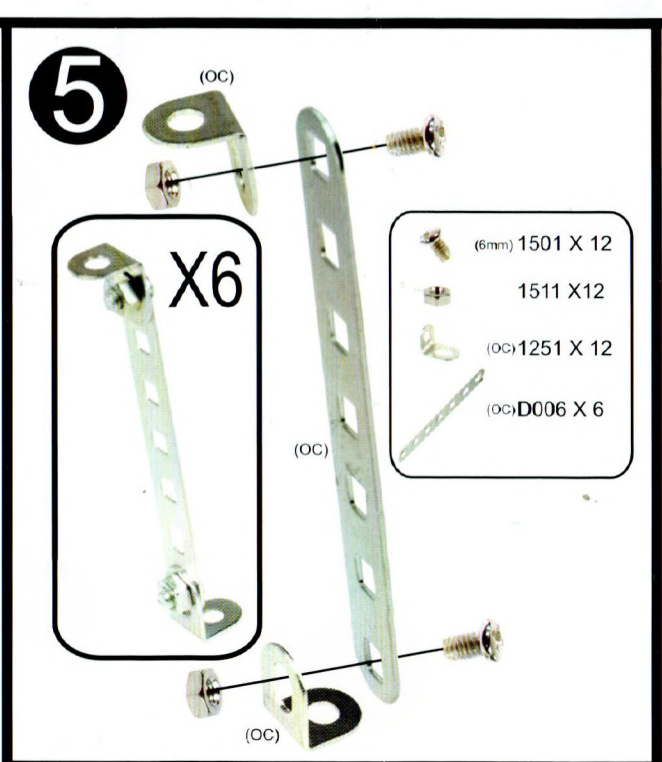
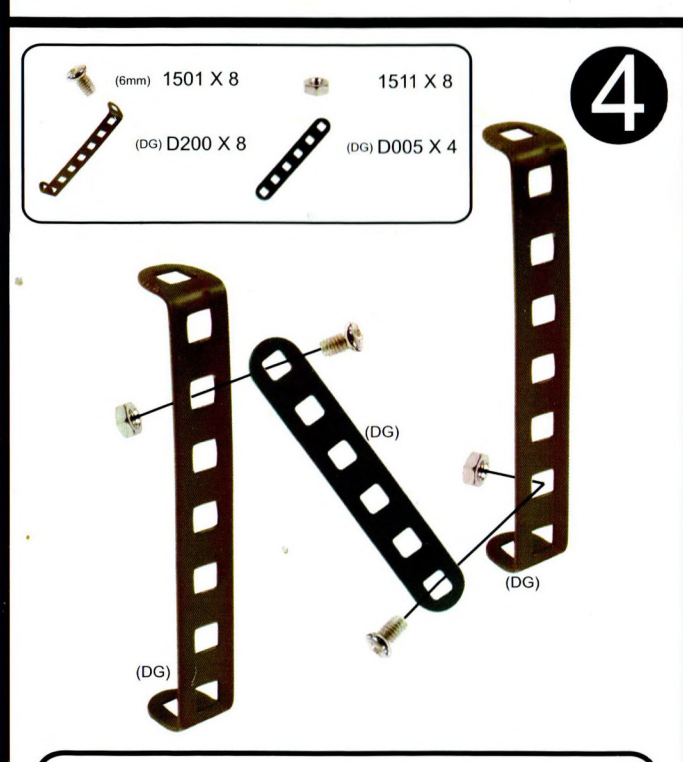
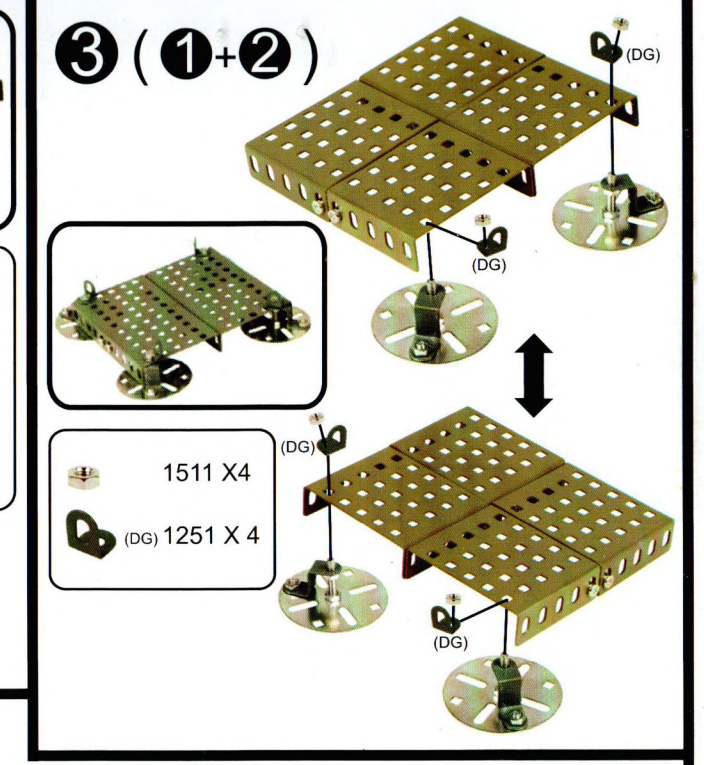
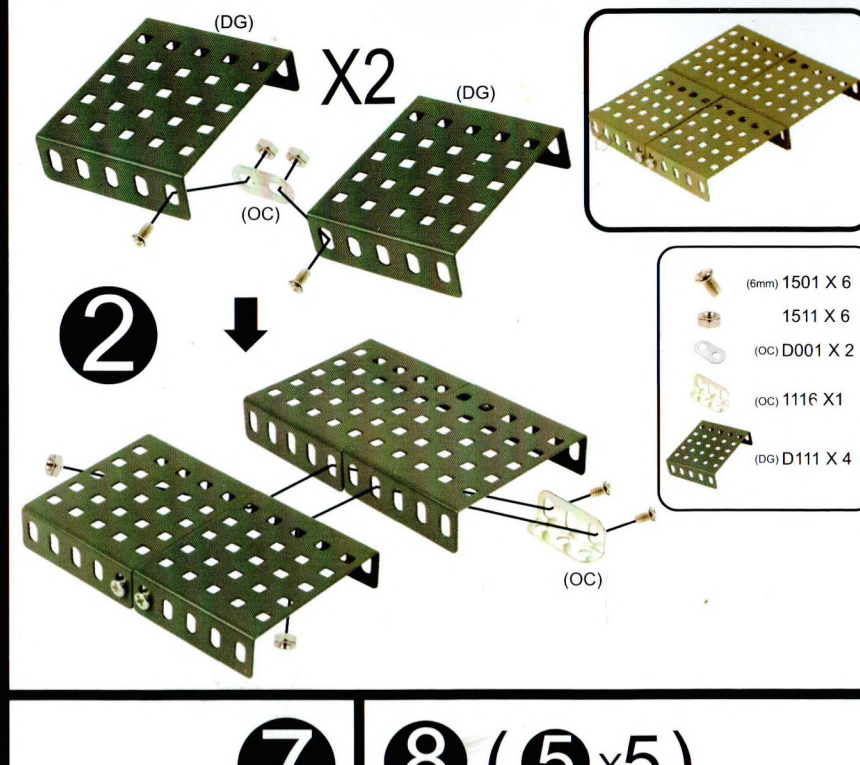
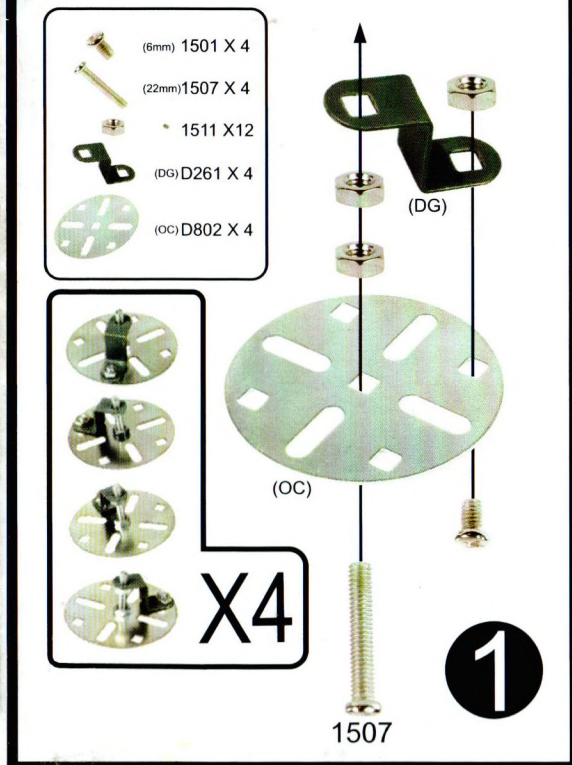
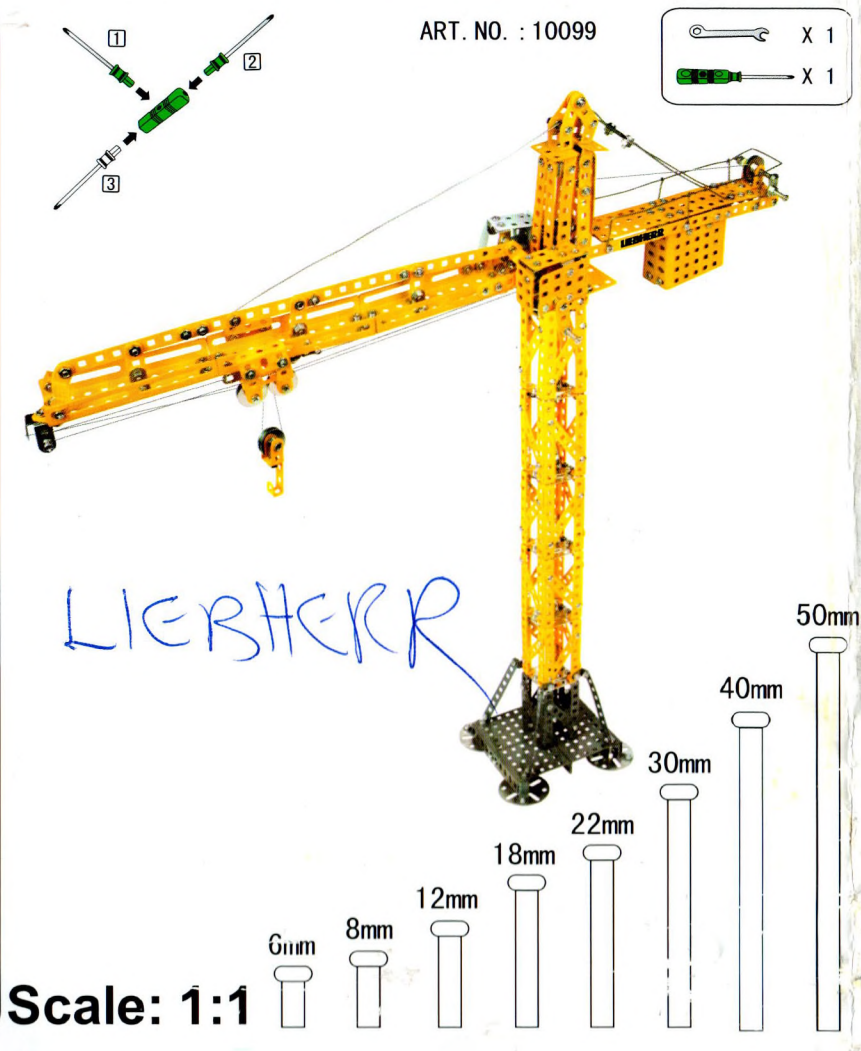

**21**

(OC) 1502  
(YC) 1501 X 4  
(OC) 1511 X 4  
(OC) 1502 X 1  
1511 X 3  
(OC) D126 X 1  
(OC) D153 X 1

**22**

(YC) 1501 X 4  
(OC) 1511 X 4  
(OC) 1502 X 1  
1511 X 3  
(OC) D126 X 1  
(OC) D153 X 1

**23 (21+22)**

(OC) 1501 X 2  
1511 X 2

**24 (20+23)**

(6mm) 1501 X 8  
1511 X 8  
3034 X 1

**25 (19+24)**

(OC) 1501 X 2  
(OC) 1508 X 1  
(OC) 1511 X 7  
(OC) D208 X 1

**26**

(YC) 1501 X 4  
1511 X 4  
(OC) D126 X 2

**27 (26)**

(OC) 1501 X 2  
1511 X 2

**28**

(OC) 1501 X 2  
1511 X 2  
(OC) 3035 X 2

(165mm)  
(165mm)

**29 (27)**

(OC) 1501 X 8  
1511 X 8  
(OC) D205 X 2  
(OC) D111 X 2

**30 (25+28+29)**

(6mm) 1501 X 2  
1511 X 4  
(OC) D007 X 1

**31**

(OC) 1501 X 1  
(OC) 1508 X 1  
(OC) 1511 X 3  
(OC) 1512 X 4  
(OC) D004 X 1  
(OC) D002 X 1  
1506

**32**

(OC) 1501 X 1  
(OC) 1505 X 2  
(OC) 1506 X 1  
(OC) D002 X 1  
(OC) 1511 X 11  
(OC) D205 X 1  
(OC) 1152 X 2  
(OC) 1304 X 1

**33**

(OC) 1501 X 4  
1511 X 4  
(OC) D002 X 1  
(OC) 1118 X 2

**34 (33)**

(OC) 1501 X 7  
(OC) D001 X 2  
(OC) 1506 X 2  
(OC) 1511 X 11  
(OC) 1401 X 2  
(OC) D205 X 2  
3037 X 1  
(OC) D102 X 1

**35**

(OC) 1501 X 3  
1511 X 3  
(OC) 1253 X 6  
(OC) D002 X 3

**36 (35X1)**

(OC) 1501 X 6  
1511 X 6  
(OC) D001 X 2  
(OC) 1051 X 2  
(OC) D100 X 1

**37 (35X1)**

(6mm) 1501 X 4  
1511 X 4  
(OC) D001 X 2  
(OC) 1051 X 2

**38 (35X1)**

(OC) 1501 X 6  
1511 X 6  
(OC) 1051 X 2  
(OC) D281 X 2

**39**

(6mm) 1501 X 4  
1511 X 4  
(OC) D007 X 4

**40 (34+36+37+38+39)**

(OC) 1501 X 10  
(OC) 1506 X 2  
1511 X 16  
(OC) 1151 X 2  
(OC) 1152 X 2  
(OC) 1252 X 1  
(OC) D205 X 2  
(OC) 1401 X 1  
(OC) 3036 X 1

**41**

(OC) 1501 X 8  
1511 X 4  
(OC) D007 X 4  
(OC) 1253 X 2

**42**

(16mm) 1506 X 2  
1511 X 6  
(OC) D002 X 4  
(OC) D205 X 2  
1506

**43 (41+42)**

(OC) 1501 X 10  
(OC) 1511 X 10  
(OC) D201 X 2  
(OC) D007 X 4

**44 (43)**

(16mm) 1505 X 1  
1511 X 1

**45**

(OC) 1501 X 2  
1511 X 2  
(OC) 1251 X 1  
(OC) 1252 X 1  
(OC) 1619 X 2

**46**

(OC) 1501 X 2  
1511 X 2  
(OC) D126 X 1  
(OC) 1501 X 2  
1511 X 2  
(OC) D004 X 1  
(OC) D001 X 1  
(OC) D002 X 1

**47**

(OC) 1501 X 2  
1511 X 2  
(OC) D004 X 1  
(OC) D001 X 1  
(OC) D002 X 1

**48**

(OC) 1501 X 2  
1511 X 2  
(OC) D126 X 1

**49 (45+46+47+48)**

(OC) 1501 X 2  
1511 X 2  
(OC) 1251 X 1  
(OC) 1252 X 1  
(OC) 1619 X 2

**50**

(OC) 1501 X 3  
1511 X 3  
(OC) D126 X 1  
(OC) D251 X 2  
(OC) D005 X 1  
(OC) D253 X 1

**51**

(OC) 1501 X 1  
1511 X 1  
(OC) D126 X 1  
(OC) D251 X 1  
(OC) D004 X 1  
(OC) D004 X 1

**52**

(OC) 1501 X 3  
1511 X 3  
(OC) D101 X 1  
(OC) D126 X 1  
(OC) 1251 X 3  
(OC) D126 X 1

**53**

(OC) 1506 X 1  
1511 X 4  
(OC) 1373 X 1  
(OC) D002 X 1

**54 (50+51+52+53)**

(OC) 1501 X 7  
1511 X 11  
(OC) 1151 X 2  
(OC) 1401 X 1  
(OC) 1251 X 3  
(OC) D114 X 1

**55**

(OC) 1501 X 6  
1511 X 6  
(OC) D126 X 1  
(OC) D005 X 1  
(OC) 1253 X 1

**56**

(OC) 1501 X 7  
1511 X 11  
(OC) 1401 X 1  
(OC) 1251 X 3  
(OC) D114 X 1

**57**

(OC) 1501 X 7  
1511 X 11  
(OC) 1401 X 1  
(OC) 1251 X 3  
(OC) D114 X 1

**58**

(OC) 1501 X 7  
1511 X 11  
(OC) 1401 X 1  
(OC) 1251 X 3  
(OC) D114 X 1

**59**

(OC) 1501 X 7  
1511 X 11  
(OC) 1401 X 1  
(OC) 1251 X 3  
(OC) D114 X 1

**60**

(OC) 1501 X 7  
1511 X 11  
(OC) 1401 X 1  
(OC) 1251 X 3  
(OC) D114 X 1

**61**

(OC) 1501 X 7  
1511 X 11  
(OC) 1401 X 1  
(OC) 1251 X 3  
(OC) D114 X 1

**62**

(OC) 1501 X 7  
1511 X 11  
(OC) 1401 X 1  
(OC) 1251 X 3  
(OC) D114 X 1

**63**

(OC) 1501 X 7  
1511 X 11  
(OC) 1401 X 1  
(OC) 1251 X 3  
(OC) D114 X 1

**64**

(OC) 1501 X 7  
1511 X 11  
(OC) 1401 X 1  
(OC) 1251 X 3  
(OC) D114 X 1

**65**

(OC) 1501 X 7  
1511 X 11  
(OC) 1401 X 1  
(OC) 1251 X 3  
(OC) D114 X 1

**66**

(OC) 1501 X 7  
1511 X 11  
(OC) 1401 X 1  
(OC) 1251 X 3  
(OC) D114 X 1

**67**

(OC) 1501 X 7  
1511 X 11  
(OC) 1401 X 1  
(OC) 1251 X 3  
(OC) D114 X 1

**68**

(OC) 1501 X 7  
1511 X 11  
(OC) 1401 X 1  
(OC) 1251 X 3  
(OC) D114 X 1

**69**

(OC) 1501 X 7  
1511 X 11  
(OC) 1401 X 1  
(OC) 1251 X 3  
(OC) D114 X 1

**70**

(OC) 1501 X 7  
1511 X 11  
(OC) 1401 X 1  
(OC) 1251 X 3  
(OC) D114 X 1

**71**

(OC) 1501 X 7  
1511 X 11  
(OC) 1401 X 1  
(OC) 1251 X 3  
(OC) D114 X 1

**72**

(OC) 1501 X 7  
1511 X 11  
(OC) 1401 X 1  
(OC) 1251 X 3  
(OC) D114 X 1

**73**

(OC) 1501 X 7  
1511 X 11  
(OC) 1401 X 1  
(OC) 1251 X 3  
(OC) D114 X 1

**74**

(OC) 1501 X 7  
1511 X 11  
(OC) 1401 X 1  
(OC) 1251 X 3  
(OC) D114 X 1

**75**

(OC) 1501 X 7  
1511 X 11  
(OC) 1401 X 1  
(OC) 1251 X 3  
(OC) D114 X 1



55 (44+49+54)

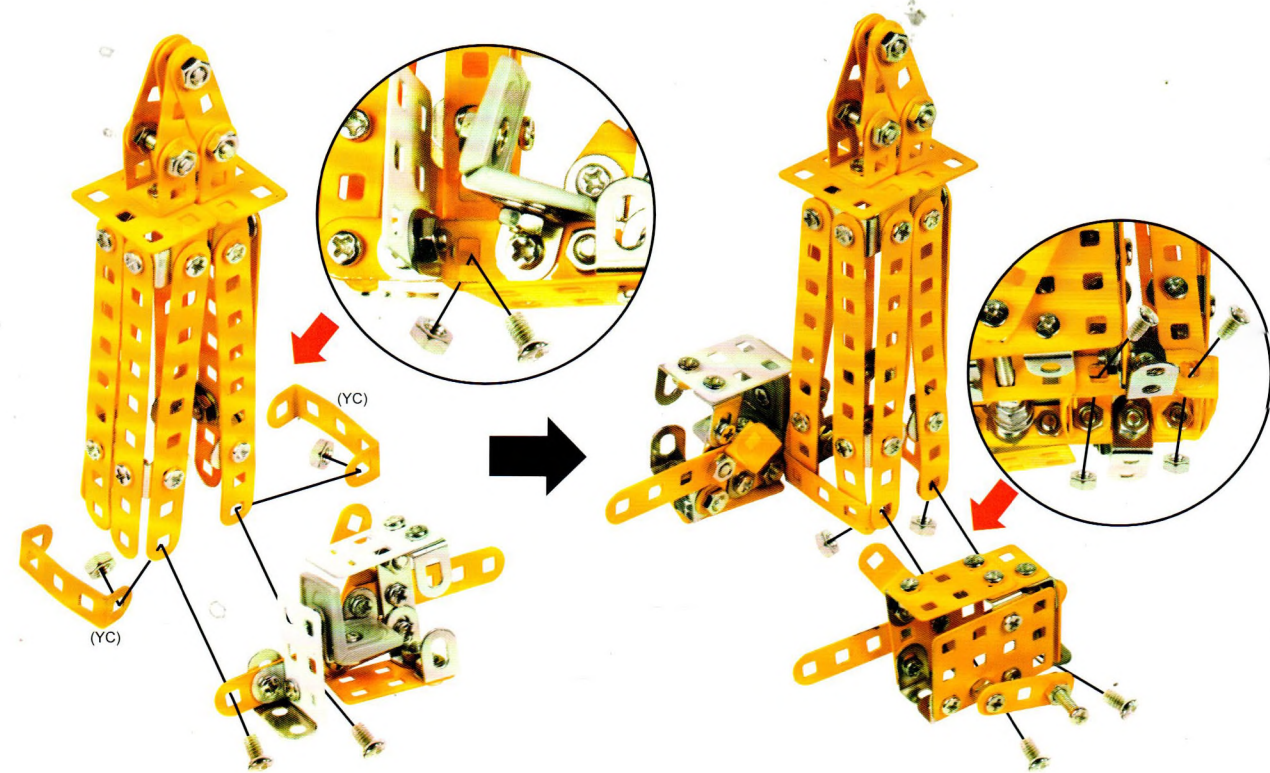

- (6mm) 1501 X 4
- 1511 X 4
- (YC) D221 X 2

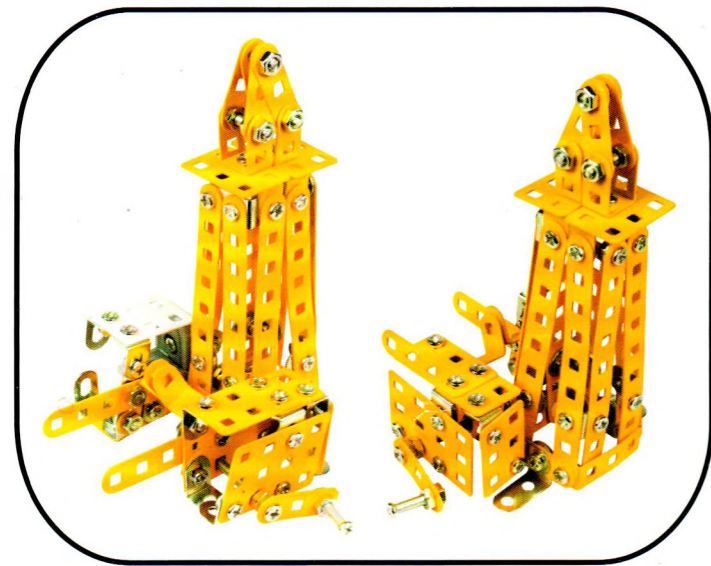

56 (30+32+55)

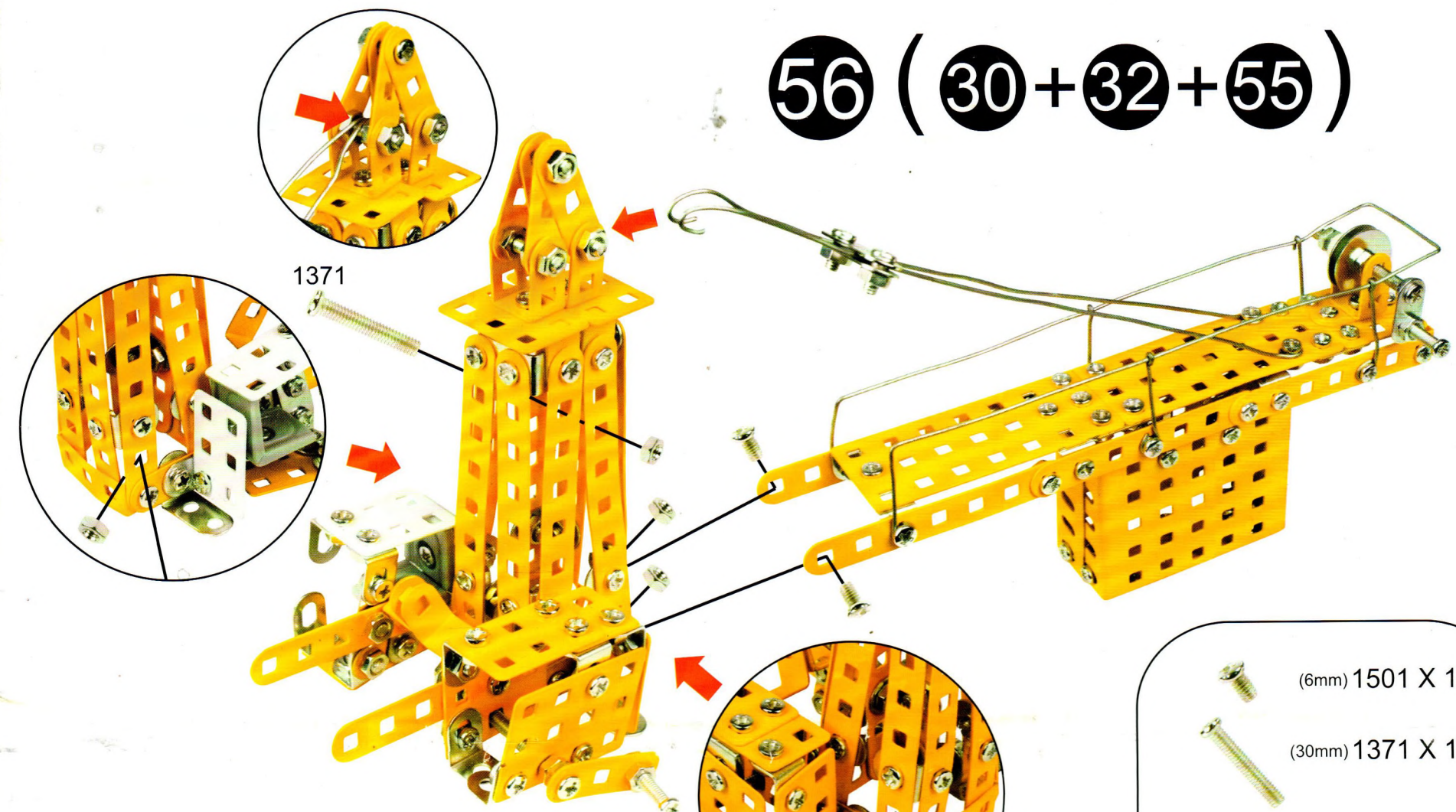

- (6mm) 1501 X 13
- (30mm) 1371 X 1
- 1511 X 14
- (OC) 1251 X 1
- (YC) D126 X 2
- (WC) D702 X 1
- 112 X 1

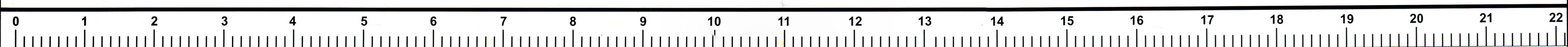
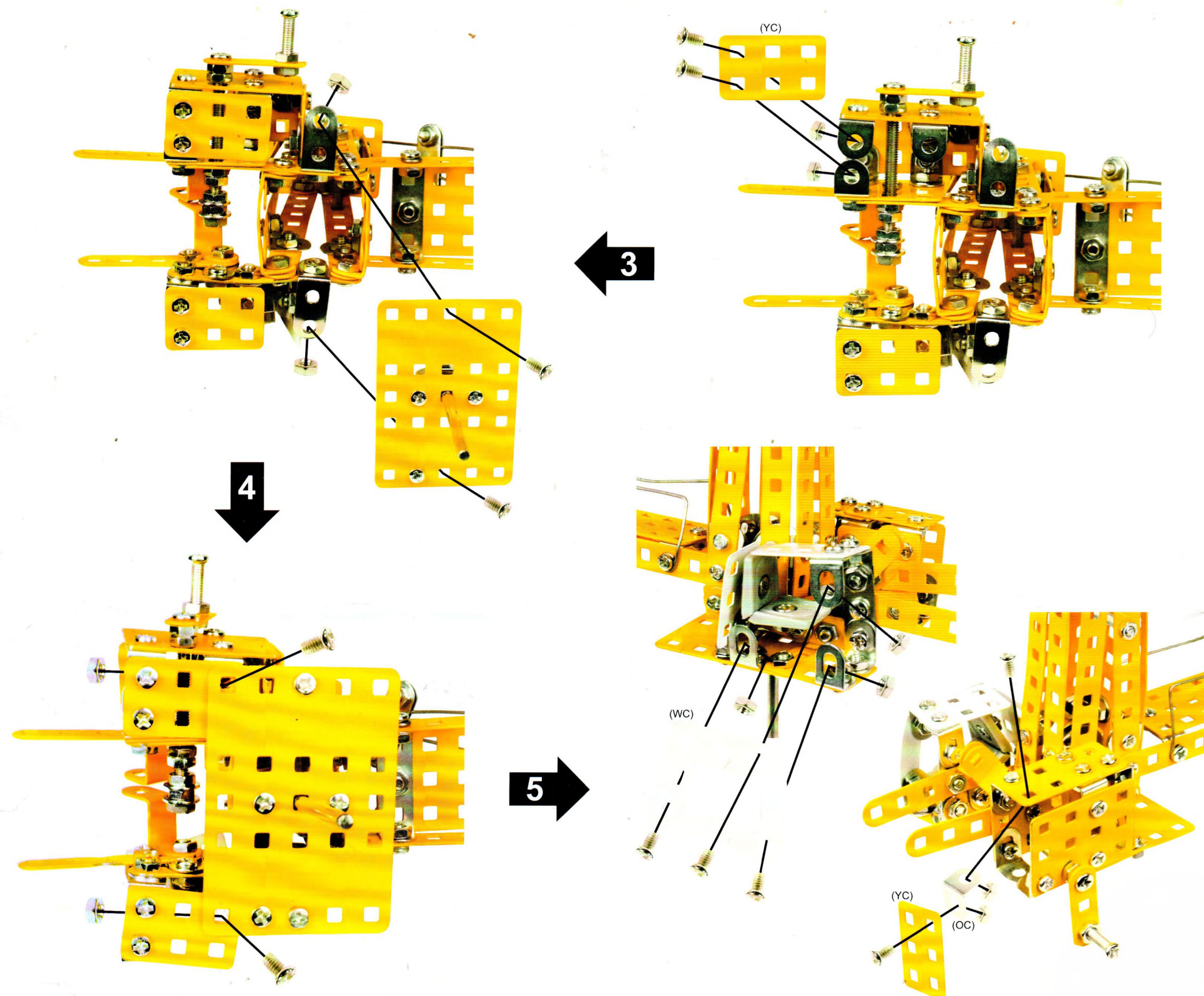
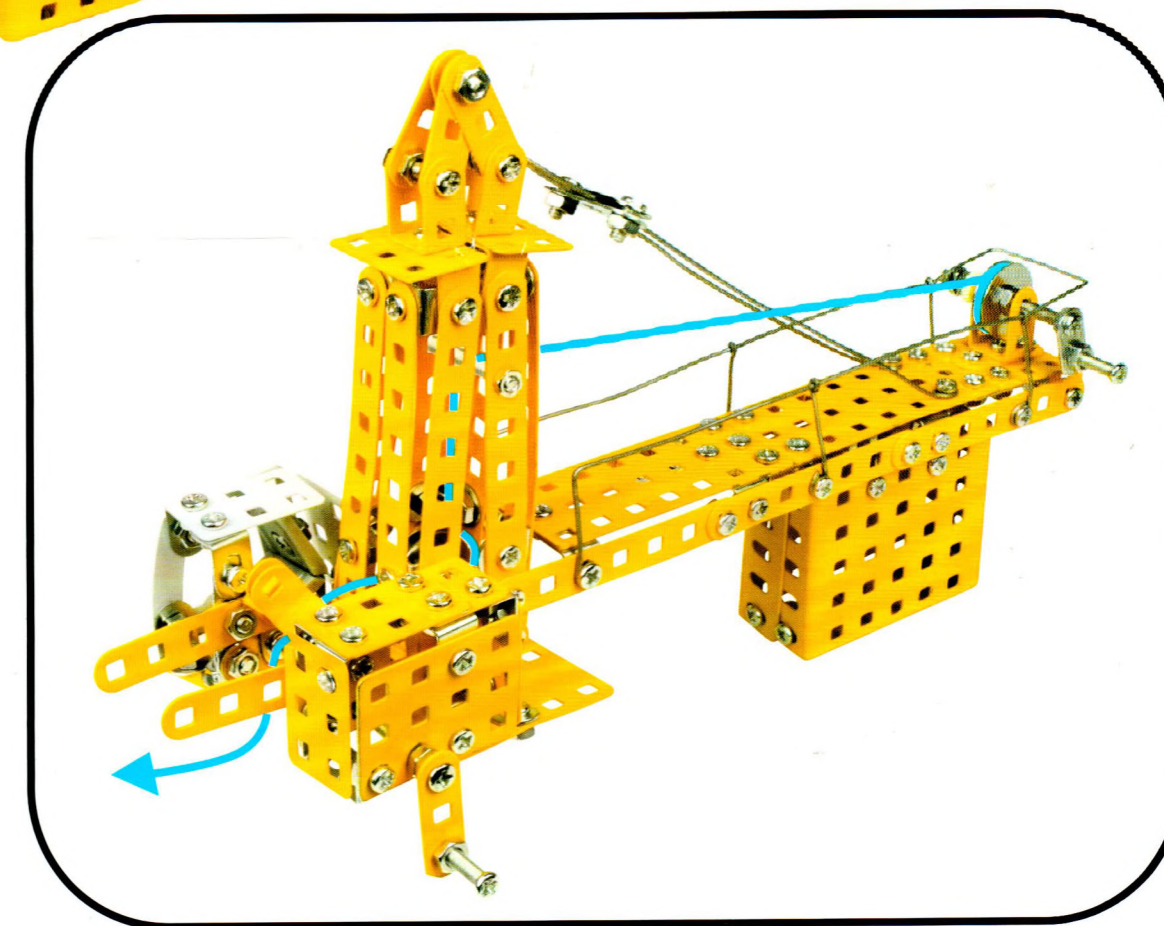
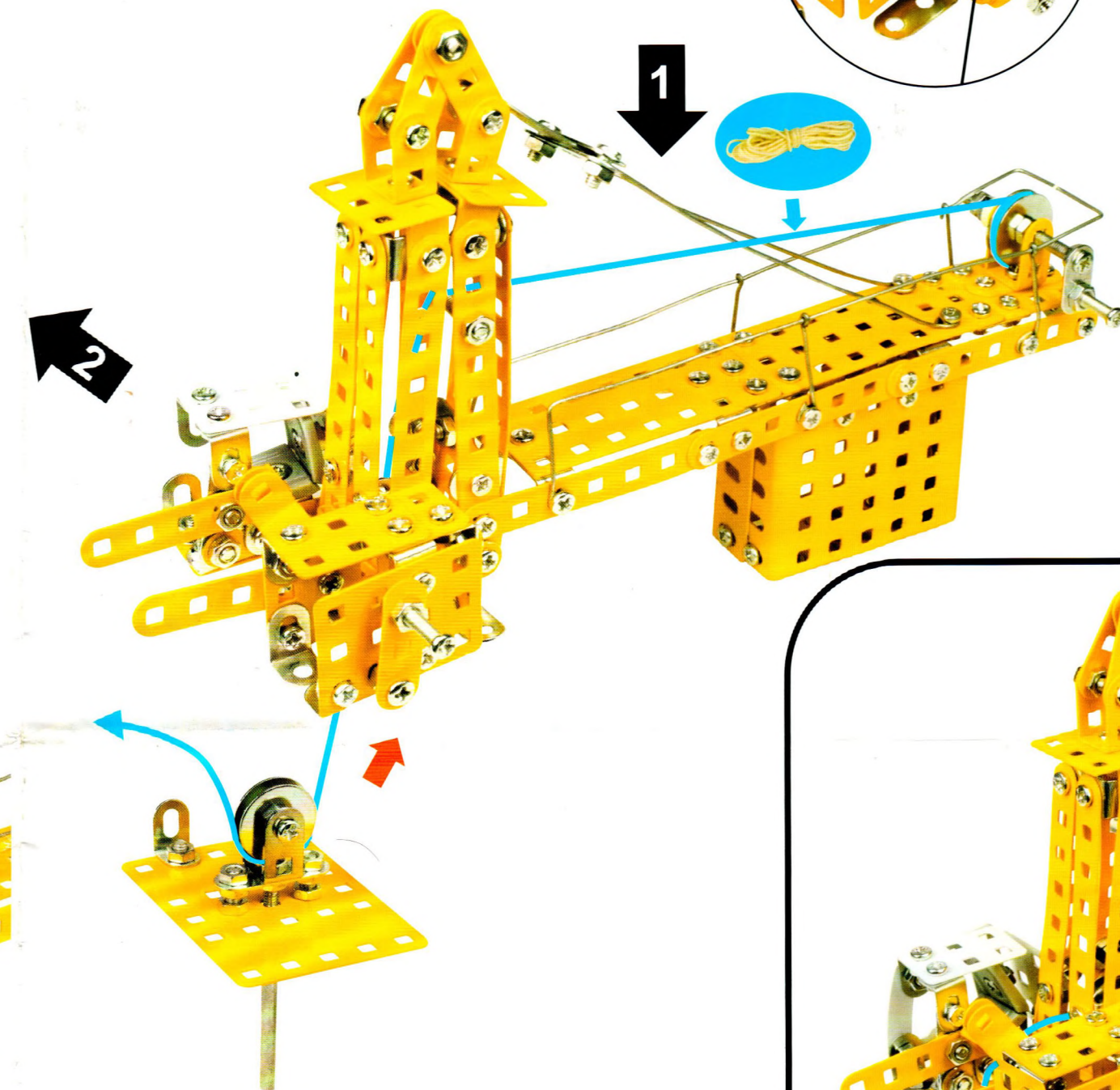



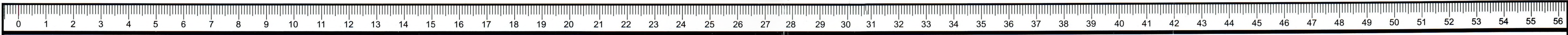

57 ( 16 + 31 + 40 + 56 )

